



30

System and product brochure

Window-sealing system

REQUIREMENTS







BACKGROUND KNOWLEDGE

SYSTEM SOLUTIONS



Background knowledge for reliable planning and implementation of window joints

The challenges – What windows have to withstand

	Sunlight
	Driving rain
	High temperature differences
	Wind
	External noise
	Movement of the building structure

The requirements – Wishes of clients and investors

	Energy efficiency
	Avoiding mould and moisture damage to structures
	Living comfort
	Protection against weathering
	Natural lighting
	Fire protection
	Movement of window/door frame
	Pleasant temperatures
	Indoor air humidity
	Ventilation
	Self-weight

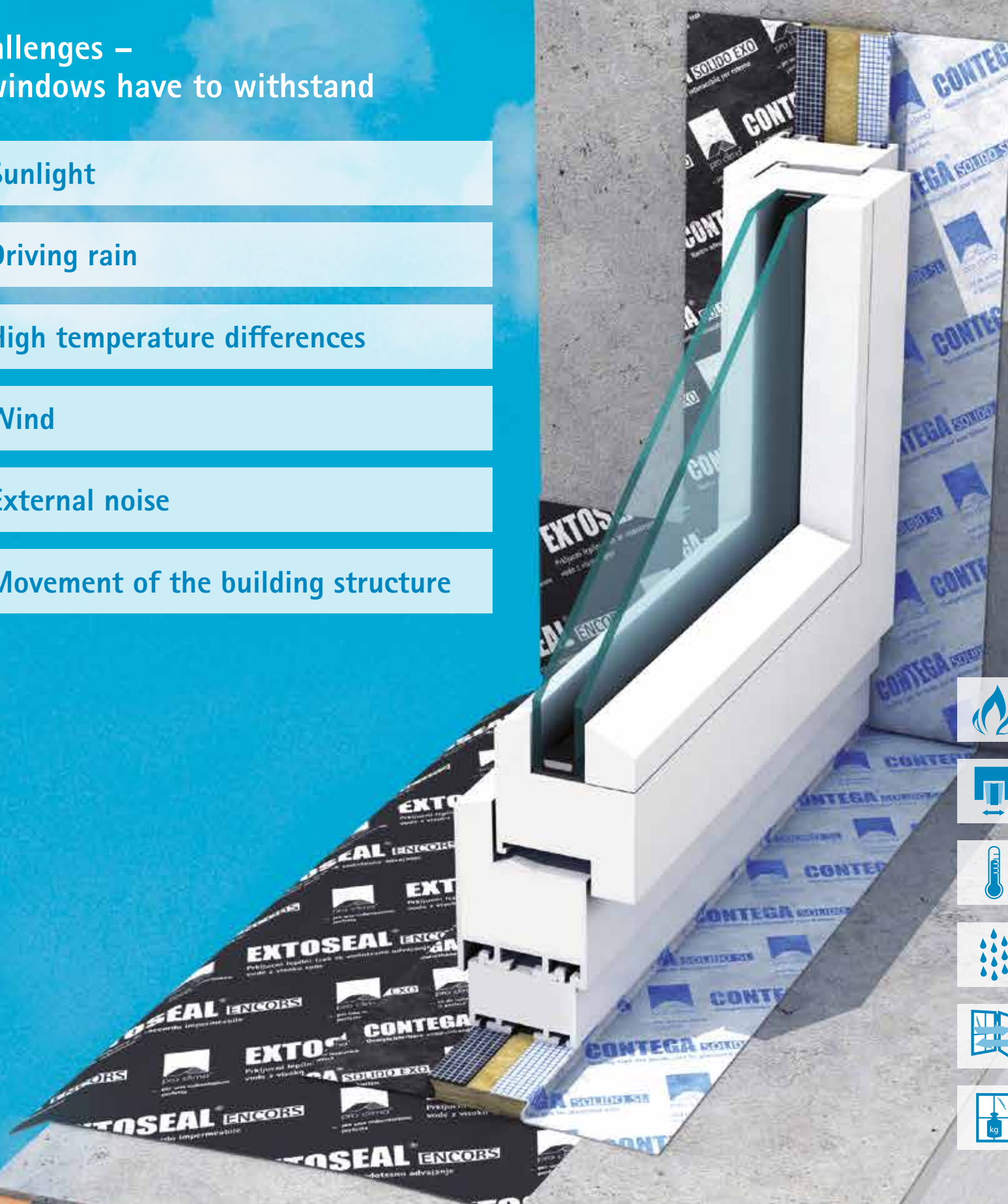

The design principle: Joints are of critical importance!

Joints between building components are always challenging – they are just a few millimetres in width, but have to do the same job as an exterior wall with a thickness of 40 centimetres. Alongside the external influences that act on a building component, there are also laws and standards that stipulate requirements that joints have to fulfil. The wishes of clients or investors are additional considerations that have to be taken into account. The quality and performance of window joints are dependent on good planning, installation according to the three-layer principle, and the choice of materials used.

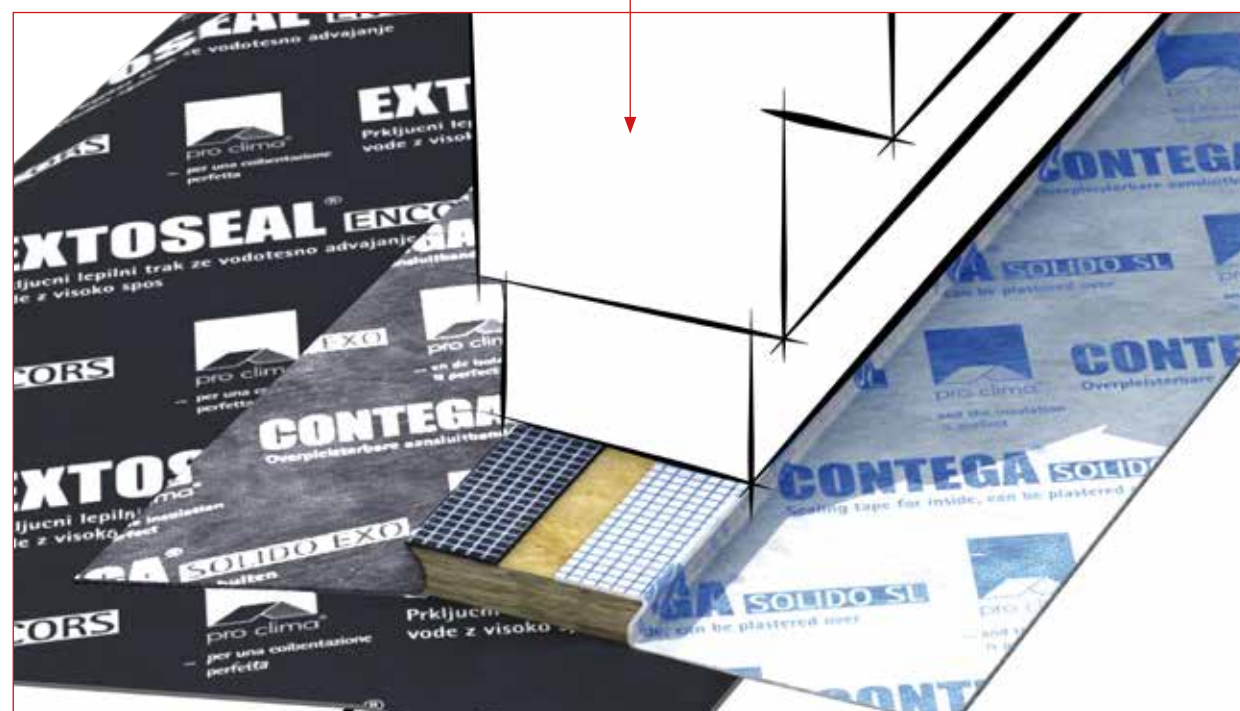
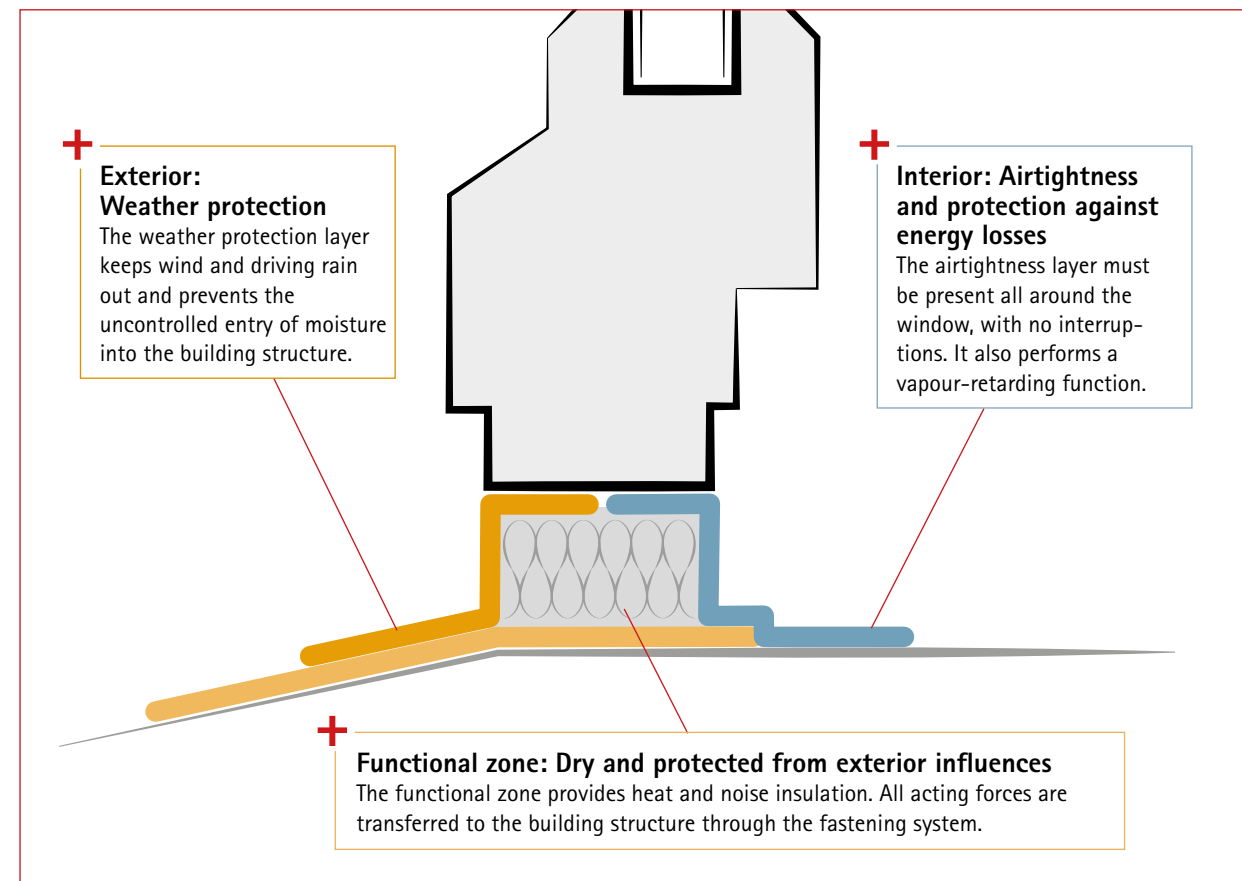

The logic behind the three functional layers

1. Exterior: Weather protection

Windtightness and sealing against driving rain are crucial components of a reliable, well-protected structure. Weather protection must prevent the entry of water into the building and the structure to ensure that the walls and windows can perform their functions properly, as planned. Windtightness prevents the flow of cold outdoor air through the joint insulation; rain protection prevents the entry of rain into the structure and/or joint. The entry of rain from the outside into or through the building structure can lead to failure of this structure and to mould formation. Windtightness ensures the effectiveness of the insulation and prevents localised cooling on interior surfaces. Ideally, this layer should be more diffusion-open than the airtightness layer. In this way, any moisture that has entered or any condensation that has formed during wintertime can dry out again. A carefully installed windtightness layer also helps to prevent air currents. It provides protection against wind, rain and snow.

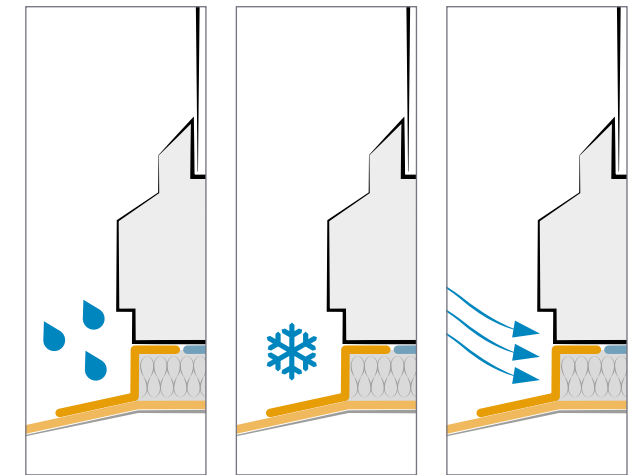

Protection against rain, snow and wind

2. Interior: Airtightness

Established best practice has recognised the importance of airtightness for roofs and exterior walls for many years now, and this requirement particularly applies to window joints. The overall reliability, performance and durability of building components depend various factors: one of the most important characteristics of insulated structures in this context is airtightness. In the case of window joints, air currents can have impacts on both sides – interior and exterior. In winter, cold air will flow in through any leaks in the joint, cool down interior surfaces and thus create higher air humidities. Mould and condensation can then be expected. If warm room air flows outwards, moisture damage can be expected on the exterior – with ice formation, algae and mould. The formation of condensation both inside and outside the structure can lead to significant damage to structures and to mould that is harmful to human health. An airtight joint at the window joint helps to avoid this type of damage to structures as well as risks to human health.

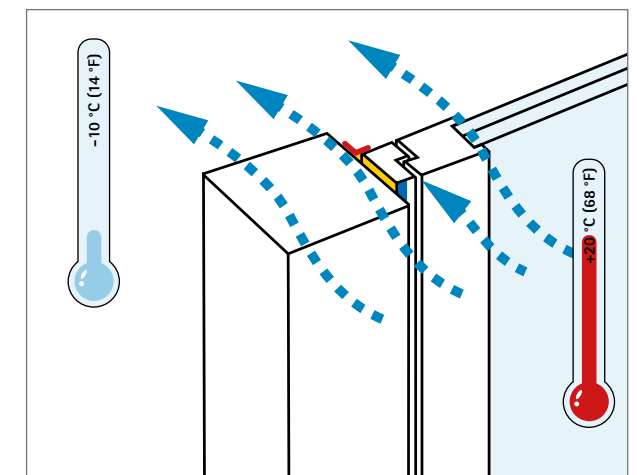

Diffusion flow in winter: molecular transport of humidity through the building component and joint.

3. Functional zone: Joint insulation

All of the functions of the wall and window also have to be performed by joints in an extremely compact space. Any deficiencies, gaps or flaws in this area directly affect the thermal insulation and noise protection. Full performance can only be achieved with a properly sealed and fully insulated joint. The joint determines the quality of the overall building envelope. It acts as a thin separation between the interior and exterior environments, and it must be protected against the elements and remain dry and airtight. If the quality of the joint and the joint insulation is neglected, cold and/or damp surfaces could result, which in turn lead to damage to structures and mould.

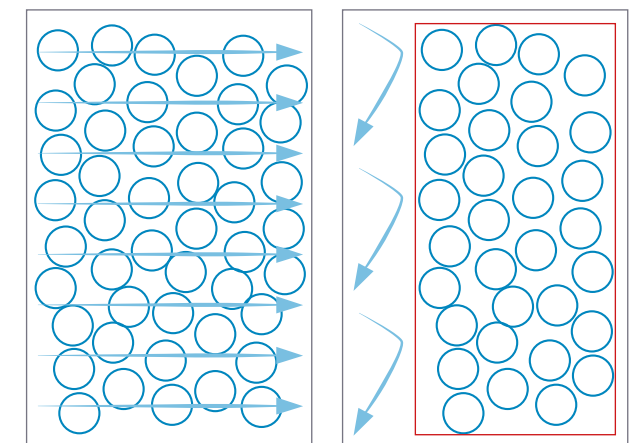

Comparison of unprotected and protected insulation: no air movements within the porous structure are possible on the right. Full insulation effect.

Energy efficiency

Only an airtight structure is energy-efficient, regardless of its size or whether the structure is an entire roof or a window joint. Airtightness ensures that the joint performs in an optimal manner. This reduces heating costs, and is thus beneficial from both a financial and a climate-protection viewpoint.

A small matter, but with a major impact!

Even the smallest leaks in the airtightness layer – e.g. those due to window joints that are not installed properly – allow warm room air to escape quickly to the outside. They can thus lead to an increase in heating costs relative to airtight building components. Inadequate airtightness reduces the cost-effectiveness of thermal insulation for building owners.

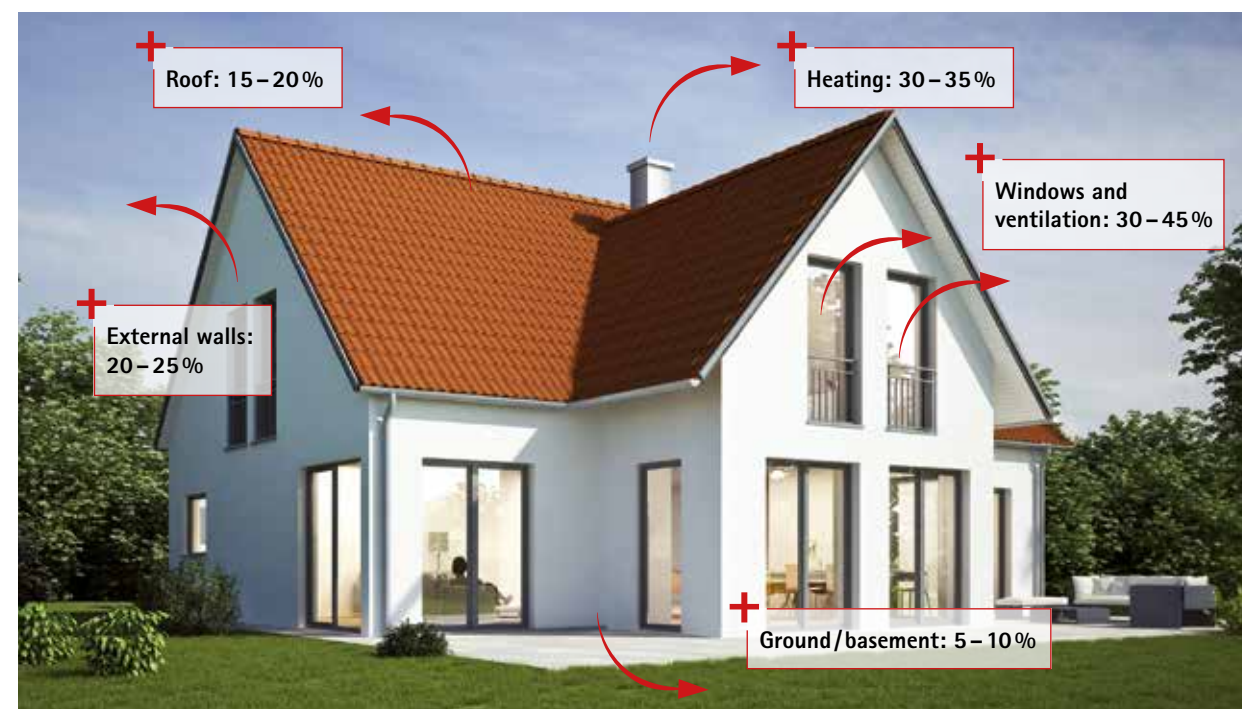
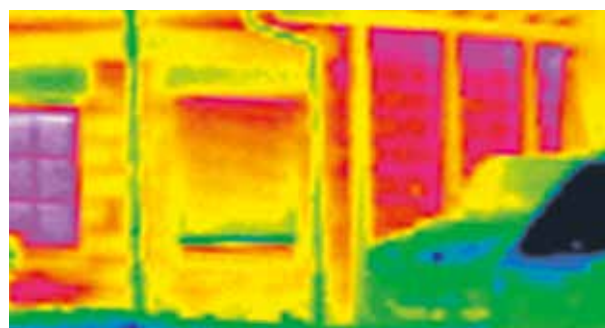

A leaky and insufficiently insulated building envelope causes heating energy losses. Windows and doors – and the professional installation of these components – have a major influence on this. This is demonstrated by this example of a detached single-family house, built in 1984. (Source: saena)

A leaky building envelope: High heating costs

A house with a living space of 80 m² and inadequate airtightness uses just as much heating energy as an airtight house with a living space of around 400 m². A large fraction of the heat losses here take place through the windows and doors. These energy losses can be avoided if building components and joints are sealed in a professional manner. (Source: dena)

Airtight building envelope: Low heating costs

On average, houses in Central Europe consume 22 litres of oil or 220 kWh of gas per m² of living space for heating. For the sake of comparison, a house built to current requirements for airtightness and thermal insulation uses just 3 litres of oil/m² of living space, while a passive house consumes only 1 litre/m².

Healthier buildings

Effective airtightness protects against mould and prevents draughts. Excessively dry indoor air is avoided in wintertime and rooms stay cooler longer in summer. All transitions need to be implemented in an airtight manner on the inside to allow the building envelope to perform in this way.



Draughts

Gaps in the airtightness layer can result in draughts in indoor rooms, depending on the pressure conditions in and around the building. Draughts not only create an uncomfortable sensation, but may also make people sick. If a light air current is continually present, the body gets used to it and the person is then not inclined to take remedial measures against draughts. The mucous membranes and muscles cool down, and colds and muscle tension can result.

Mould

Defective window joints can lead to mould formation. If humid, warm indoor air enters into a building component through a leaky airtightness layer, condensation formation on the inside and thus also mould growth may result. If cold outdoor air enters the building through a leak, the surface temperature drops at the entry point. If warm indoor air meets this cooled-down surface, the relative humidity is increased and condensation may form. In this scenario, there is a risk of mould on surfaces.

Many mould fungi release poisons – such as MVOCs (microbial volatile organic compounds) – and spores as secondary metabolic products that are harmful to human health. Mould is regarded as a leading cause of allergies. It does not matter whether these MVOCs or spores enter into the human body through food, i.e. through the stomach, or through the air into the lungs. Humans should avoid all contact with mould fungi.



Dry indoor air in winter

The frequently observed phenomenon of dry indoor air in winter is a result of the entry of cold outdoor air into buildings through gaps in the building envelope. If this cold air is warmed up by heating, its relative humidity content reduces.

For this reason, buildings with poor airtightness tend to have air that is too dry in winter, and this cannot be significantly improved by humidification equipment. The consequence is an unpleasant indoor climate.

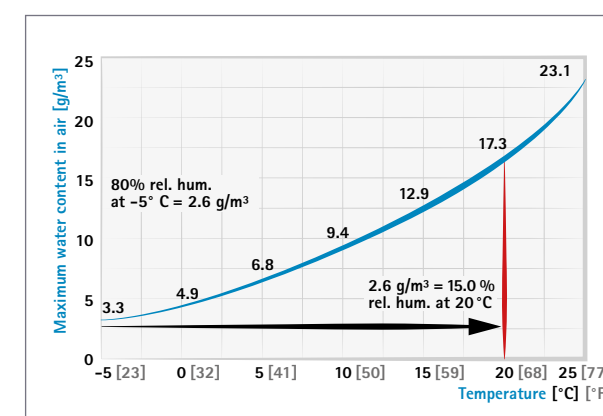

An example:

Cold air at -5 °C and 80% relative humidity can absorb a maximum of 2.6 g/m³ of moisture. If this air is heated to 20 °C, the relative humidity falls to 15%. This value is much too low for a healthy indoor climate. A relative humidity of 40 to 50% is generally perceived to be pleasant at 20 °C.



More information on this topic:

proclima.info/en/energy-efficiency



Avoiding moisture damage

Damage to building structures due to rotting and mould can occur if humid, warm indoor air enters into the functional layer in winter – e.g. through window joints that have not been installed professionally – and condensation is formed. This is avoided if the joint is installed in an airtight manner on the inside. The three causes of moisture in and on building components are:

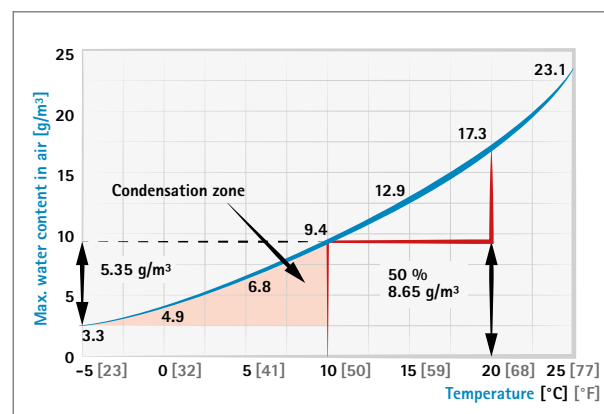

Condensation

Air has only a limited capacity for holding water that depends on its temperature. It has a higher uptake capacity at high temperatures, and a lower capacity at low temperatures. If the temperature of the air drops, all that happens initially is that the relative humidity increases. However, if the temperature drops even further, the limit curve of the uptake capacity is reached: the 100% saturation curve. If the temperature drops even further beyond this point, the air can no longer store its initial water content and condensation forms. As an example, the behaviour of air at 20 °C and 50% relative humidity is described. At 20 °C and 50% relative humidity, 8.65 g of water/m³ is stored in the air. If the temperature drops, condensation forms from 9.3 °C onwards: the boundary curve for 100% saturation has been reached. If the temperature drops even more, an increasing amount of condensation is formed and the risk of damage to structures increases.

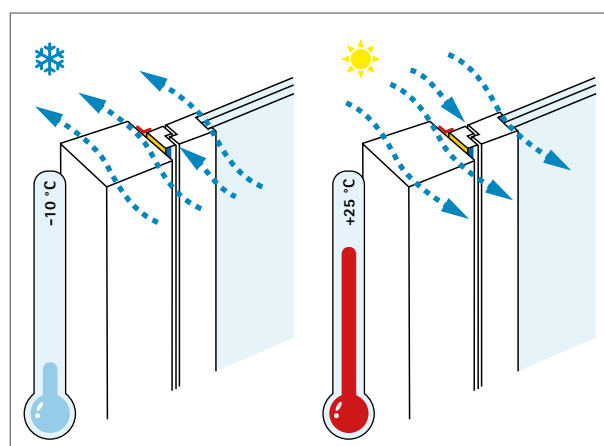

Diffusion

Vapour diffusion refers to the process of moisture transport by means of molecular movement. The driving force is the difference in vapour pressure between the outdoor and indoor environments. In contrast with convection, moisture transport takes place not by means of an air current, but rather through the movement of water vapour molecules through the building component. The direction of the diffusion flow is generally from the inside to the outside in winter, and from the outside to the inside in summer.

The diffusion flow is regulated by the differing resistances (s_d values) of the individual material layers. An outer layer (e.g. outer sheeting on the window joint) with a low s_d value allows a lot of moisture to leave the structure. A good design principle is: a building component should become increasingly diffusion-open as you move towards the outside. Layers that have variable s_d values facilitate intelligent management of moisture and help to achieve balanced conditions within the structure.

Convection

Convection refers to a current of air – resulting in this case from leaks in the building envelope. It is driven by two factors: the incident wind flow around the building and the pressure conditions inside the building. Temperature distribution, volume and building height are additional factors inside the building that affect convection. Air currents – i.e. the convective transport of humidity through and/or into a building component – must be avoided.

The amount of moisture transported by convection is several times greater than that transported by diffusion processes; indeed, the amount of moisture that enters by convection can easily be 1,000 times greater than that entering by diffusion.

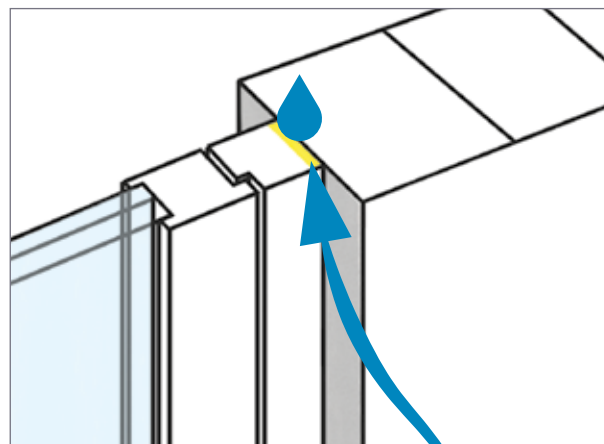

Protection against moisture and mould

The interior and exterior sealing layers must be correctly installed and must work properly in order to prevent damage to structures and risks to human health.

The interior and exterior sealing layers are not sealed

Humid, warm indoor air flows through the joint. Condensation is formed. Precipitation water from the outside penetrates into the wall structure.

- ✗ The functional layer becomes damp
- ✗ Uncontrolled heat losses
- ✗ Continuous air and wind flows
- ✗ Risk of complete failure of the building component
- ✗ Risk of mould formation

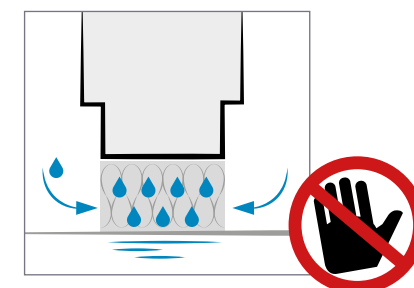

The exterior sealing layer is sealed, the interior sealing layer is not sealed

Humid, warm indoor air flows through the joint. Condensation is formed.

- ✗ The functional layer becomes damp
- ✗ The performance of the insulation is reduced
- ✗ The structure becomes damp
- ✗ Risk of mould formation

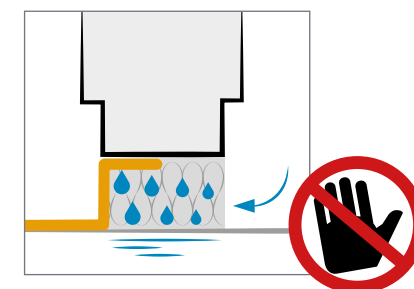

The interior sealing layer is sealed, the exterior sealing layer is not sealed

The joint is not protected against wind and rain on the outside. Moisture can enter.

- ✗ The functional layer becomes damp
- ✗ Uncontrolled heat losses
- ✗ Rain enters directly into the structure
- ✗ Risk of mould formation

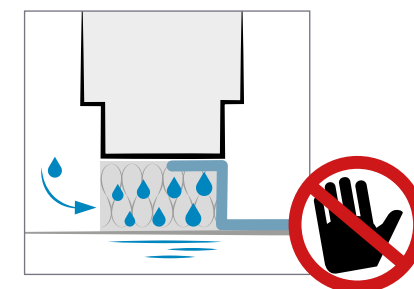

The interior sealing layer is airtight and vapour-checking, the exterior layer is windtight, resistant to driving rain and diffusion-open.

Wind or indoor air does not flow through the joint, and the functional layer can carry out its (thermal insulation) function and keeps the structure dry. The exterior of the component joint is protected against wind and rain.

- ✓ The functional layer is protected
- ✓ Air currents are avoided
- ✓ No heat losses

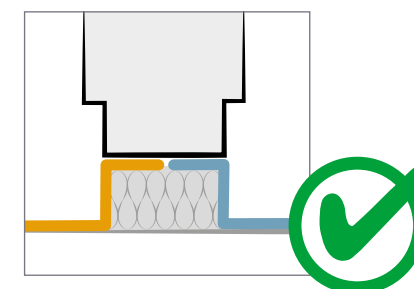

Summary:

Proper implementation of the joint is crucial!

1. Interior sealing layer = Airtight and vapour-checking
2. Functional layer = Securely fastened, provides thermal and noise insulation
3. Exterior sealing layer = Windtight, resistant to driving rain and diffusion-open

This principle corresponds to current engineering practice and the generally accepted minimum that needs to be fulfilled.

Installation position and effects of this position

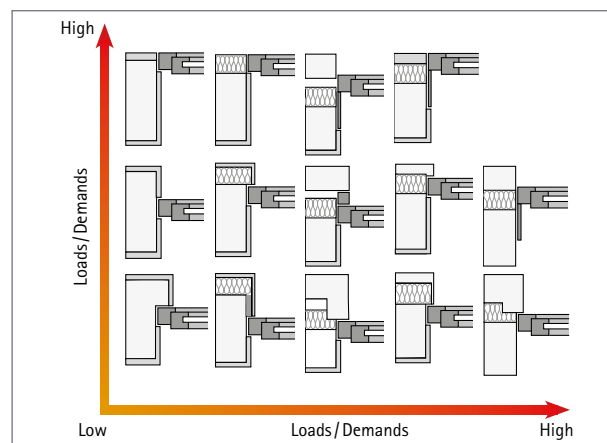

Loads and demands on the window joint

The installation position of the window in the exterior wall is dependent on the structure of the wall, the possible methods of fastening and sealing, and the design requirements on the interior and exterior.

Particular attention should be paid to reducing thermal bridges and to achieving optimised isotherm profiles.

The graph on the left shows how the loads and demands imposed on a window increase depending on its installation position.

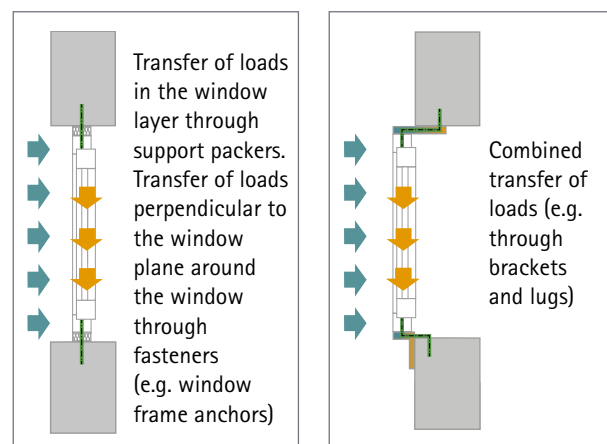

Installation position in the reveal of the supporting structure Installation position outside of the supporting structure

Fastening

All forces that can be expected to act on the window must be reliably transferred to the building structure by means of suitable fastening. The installation position determines the choice of fastening system to a significant extent. The transfer of forces to the building structure is to be taken into account accordingly during design.

Acting forces: Self-weight horizontally and vertically, additional loads due to add-on components, wind load, loads from self-weight, vertical and – if applicable – horizontal live loads

Thermal bridges

Thermal bridges refer to thermal weak points (with a higher heat flow density) in structural designs. Firstly, an increased amount of heat is lost through thermal bridges (transmission heat losses), which leads to a higher energy consumption; in addition to this, cold surfaces arise at thermal bridges in winter that can favour the formation of condensation and mould. Thermal bridges always occur at window joints as a result of the different thicknesses of the components. Depending on the wall structure, the window frame should be directly adjacent to the insulation of the exterior wall and, if necessary, covered over with insulation in order to reduce thermal bridges.

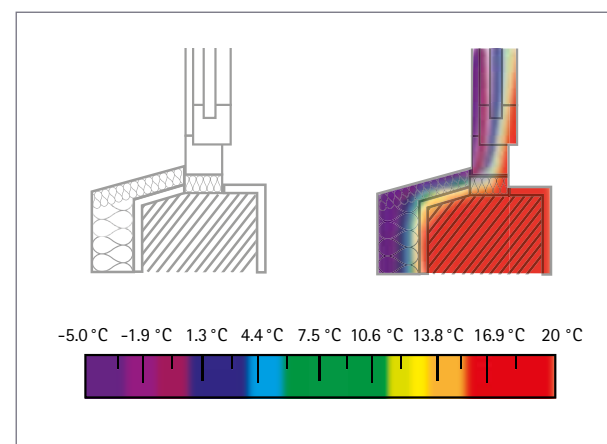

Isotherm curves

Critical temperature for the dew point and for mould fungi

Consideration of isotherm curves is a necessary part of a modern approach to planning window installation – due in part to the increase in damage to structures that can be observed. This issue is the basis for professional installation and the reliable sealing of window joints.

Isotherms run through points with the same temperature within building components. They are shown as curves or surfaces.

They are calculated on the basis of the conditions in accordance with DIN 4108-2 with an indoor temperature of +20 °C and an outdoor temperature of -5 °C. Condensation can form along the +10 °C isotherm, as indoor air with a standard climate of 20 °C and 50% relative humidity condenses around this temperature.

If this isotherm passes along building component surfaces or lies inside of the building component, the indoor air may condense and the surface will become damp. Mould and moisture damage to structures can result. However, consideration of the +13 °C isotherm is even more important in the planning of the position of the window in the building structure. At a temperature of 12.6 °C, the relative humidity (based on 20 °C/50%) takes on a value of 80%, which represents the start of a risk of mould. If this line lies within the structure, i.e. if the surface temperature is greater than 13 °C,

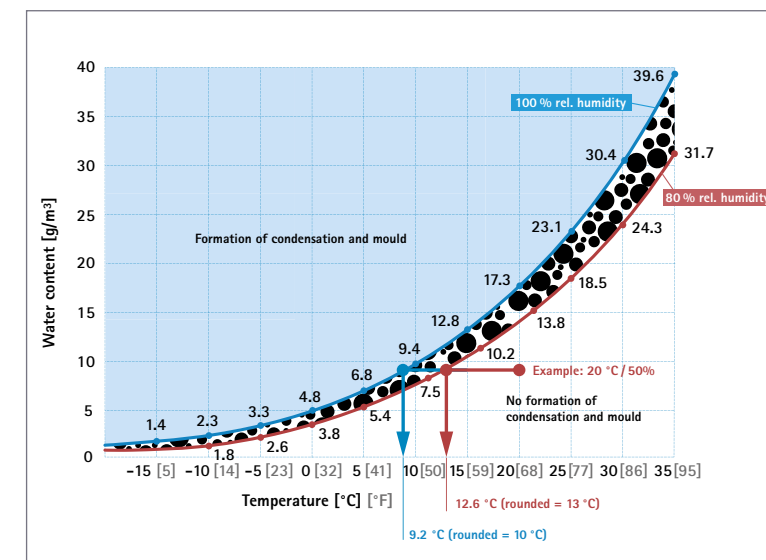

the formation of condensation or mould is impossible from a design viewpoint. The 13 °C isotherm takes into account a longer-term relative humidity of over 80% in the area close to the surface – under these conditions, mould growth can start to occur.

The position of the window is of critical importance

If a window is positioned too far to the outside, the risk of condensation on the inner window reveal increases. If a window is positioned in the middle of the structure, the outer window reveal may need to be insulated.

In the case of double-shelled wall structures or wall coverings, the windows must be installed in the same plane as the insulation layer or else with sufficient covering of the frame by insulation.

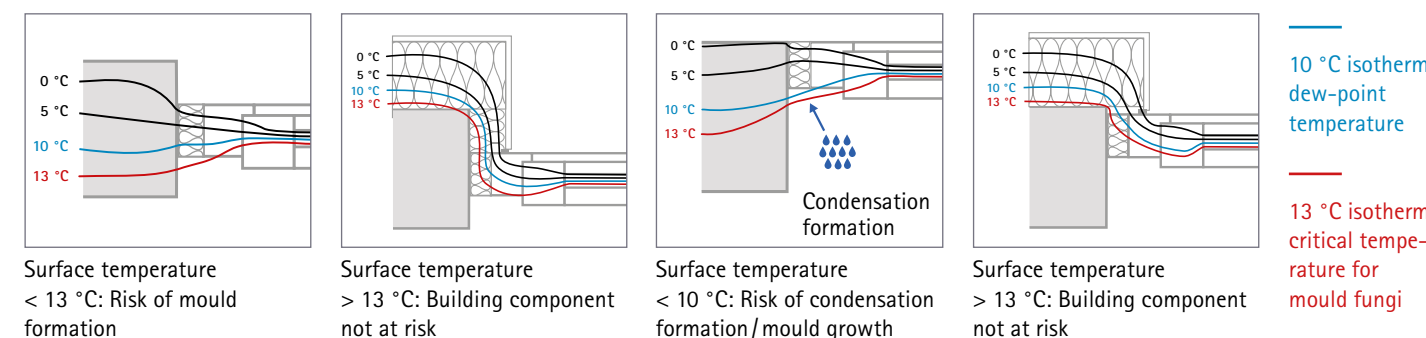

Summary:

The right installation position is of critical importance.

- ✓ Insulation covering of the frame reduces thermal bridges
- ✓ The 13 °C isotherm must be inside the structure in order to avoid surface mould
- ✓ A recessed installation position reduces weathering exposure and the susceptibility to damage

Window-sealing tapes – the same tape for interior or exterior use, e.g.

CONTEGA[®] SOLIDO IQ-D

Intelligent full-surface adhesive plaster/window-sealing tape with additional adhesive zone, for interior and exterior use

Areas of application:

For interior use for vapour-checking and airtight joints between membranes or wood-based panels and windows, doors or mineral surfaces. For exterior use for corresponding windtight joints that are resistant to driving rain. The adhesive zone on the fleece side allows for easier adhesion to windows and doors if applied before they are installed.



Advantages:

- ✓ Reliable installation: the same tape for interior and exterior use thanks to its intelligent functional membrane
- ✓ Saves time: the joint is immediately windproof and resistant to driving rain, and it can be subjected to loading
- ✓ Reliable joints: water-resistant SOLID adhesive has extremely strong adhesion on mineral subsurfaces too
- ✓ Easy to work with thanks to additional adhesive zone on the fleece side
- ✓ Extra thin: for easy folding in corner areas
- ✓ Construction in adherence with standards: for airtight sealing in accordance with DIN 4108-7, SIA 180 and RE 2020
- ✓ Fleece side can be plastered over: defined transition between window joints and plasterwork
- ✓ Excellent values in hazardous substance testing, has been tested according to the ISO 16000 evaluation scheme

Installation:



Remove the release film strip.



Create loop of slack at corner (length: 1.5 x width of gap).



Stick tape ends to one another, length: 5 cm.



Install the window, remove the release film strip and stick the tape all around the window.



Stick to be airtight or resistant to driving rain in the corners.



Rub with PRESSFIX.



Other window-sealing tapes and further information on CONTEGA SOLIDO IQ-D

- Detailed CAD drawings
- And much more:

proclima.info/en/window-sealing



For interior & exterior use

CONTEGA SOLIDO IQ
Intelligent, full-surface adhesive plaster/window-sealing tape, for interior and exterior use



NEW

CONTEGA SOLIDO IQ-X
Pre-folded, intelligent, full-surface adhesive plaster/window-sealing tape, for interior and exterior use



CONTEGA SOLIDO IQ-D
Intelligent full-surface adhesive plaster/window-sealing tape with additional adhesive zone, for interior and exterior use



CONTEGA IQ
Intelligent window-sealing tape, for interior and exterior use



Technical data:

Backing		PP backing fleece, PE copolymer special membrane
Adhesive		Modified water-resistant SOLID adhesive
Release film		Single/double-split silicone-coated PE sheet
Colour		black, print: green
s _p value, humidity-variable	EN ISO 12572	0,4 - > 25 m
Outdoor exposure		8 months
Water column	EN ISO 811	> 2 500 mm ; 8' 2"
Can be plastered over		yes
Installation temperature		above -10 °C ; 14 °F
Temperature resistance		permanent -40 °C to 90 °C ; -40 °F to 194 °F
Storage		cool and dry

Supply forms:

Length: 30 m (98' 3/8"); width: 80 mm (3 1/8"); 100 mm (4"); 150 mm (5 7/8")



CONTEGA SOLIDO IQ-D



CONTEGA SOLIDO IQ



System finder for plaster and window joints – pages 12/13

Window-sealing tapes for interior use, e.g.



CONTEGA[®] SOLIDO SL-D

Full-surface adhesive plaster/window-sealing tape with an additional adhesive zone, for interior use

Areas of application:

For interior airtight and vapour-checking joints between membranes or wood-based panels and windows, doors and mineral surfaces. The adhesive zone on the fleece side allows for easier adhesion to windows and doors if applied before they are installed.



Advantages:

- ✓ Saves time: the joint is immediately airtight and can be subjected to loading
- ✓ Easy to work with thanks to the additional adhesive zone on the fleece side
- ✓ Can be plastered over directly: defined transition between window and/or vapour check and plasterwork
- ✓ Reliable joints: water-resistant SOLID adhesive has extremely strong adhesion on mineral substrates too
- ✓ Independently confirmed suitability: tests in accordance with MO-01/1 passed at IFT in Rosenheim, Germany
- ✓ Construction in adherence with standards: for airtight bonding in accordance with DIN 4108-7, SIA 180 and RE 2020
- ✓ Excellent values in hazardous substance testing, has been tested according to the ISO 16000 evaluation scheme

Installation:



Masonry or timber structure



Stick to the side of the frame



Preparation of corners



Stick the tape all around the window frame



Install the window and insulate the joint



Stick onto the reveal and rub into place



Other window-sealing tapes and further information on CONTEGA SOLIDO SL-D

- Detailed CAD drawings
- And much more:

[proclima.info/en/
window-sealing](http://proclima.info/en/window-sealing)



CONTEGA SL
Window-sealing tape,
for interior use



CONTEGA SOLIDO SL
Full-surface adhesive plaster/
window-sealing tape, for interior use



Technical data:

Backing		PP backing fleece, PE copolymer special membrane
Adhesive		Modified water-resistant SOLID adhesive
Release film		Single/double-split silicone-coated PE sheet
Colour		white
s _d value	EN 1931	2.8 m
Airtightness	ift, MO-01/1:2007-01, Abs. 5	up to 1000 Pa, around window
Bond durability, non-aged/aged	DIN 4108-11	passed
Can be plastered over		yes
Installation temperature		above -10 °C ; 14 °F
Temperature resistance		permanent -40 °C to 90 °C ; -40 °F to 194 °F
Storage		cool and dry



© IFT Rosenheim
CONTEGA SOLIDO
SL-D

Supply forms:

Length: 30 m (98' 3/8"); width: 80 mm (3 1/8"); 100 mm (4"); 150 mm (5 7/8"); 200 mm (7 7/8")



System finder for plaster and
window joints – pages 12/13

Window-sealing tapes for exterior use, e.g.



CONTEGA[®] SOLIDO EXO-D

Full-surface adhesive plaster/window-sealing tape with an additional adhesive zone, for exterior use

Areas of application:

For exterior windtight joints that are resistant to driving rain between membranes or wood-based panels and windows, doors and mineral surfaces. The adhesive zone on the fleece side allows for easier adhesion to windows and doors if applied before they are installed.



Advantages:

- ✓ Saves time: the joint is immediately resistant to driving rain and can be subjected to loading
- ✓ Easy to work with thanks to additional adhesive zone on the fleece side
- ✓ Can be plastered over directly: defined transition between window and/or wind sealing and plasterwork
- ✓ Reliable joints: water-resistant SOLID adhesive has extremely strong adhesion on mineral subsurfaces too
- ✓ Independently confirmed suitability: tests in accordance with MO-01/1 passed at IFT in Rosenheim, Germany

Installation:



Masonry or timber structure



Stick to the side of the frame



Preparation of corners



Stick the tape all around the window frame



Install the window and insulate the joint



Stick CONTEGA SOLIDO EXO-D onto the reveal and rub into place



Other window-sealing tapes and further information on CONTEGA SOLIDO EXO-D

- Detailed CAD drawings
- And much more:

[proclima.info/en/
window-sealing](http://proclima.info/en/window-sealing)



CONTEGA EXO
Window-sealing tape,
for exterior use



CONTEGA SOLIDO EXO
Full-surface adhesive plaster / window-
sealing tape, for exterior use



Technical data:

Backing		PP backing fleece, PE copolymer special membrane
Adhesive		Modified water-resistant SOLID adhesive
Release film		Single/double-split silicone-coated PE sheet
Colour		black
s _p value	EN 1931	0.7 m
Outdoor exposure		3 months
Water column	EN ISO 811	> 2 500 mm ; 8' 2"
Resistance to driving rain	ift, MO-01/1:2007-01, Abs. 5	up to 600 Pa, around window
Bond durability, non-aged/aged	DIN 4108-11	passed
Can be plastered over		yes
Installation temperature		above -10 °C ; 14 °F
Temperature resistance		permanent -40 °C to 90 °C ; -40 °F to 194 °F
Storage		cool and dry

Supply forms:

Length: 30 m (98' 3/8"); width: 80 mm (3 1/8"); 100 mm (4")



CONTEGA SOLIDO
EXO-D



System finder for plaster and
window joints – pages 12/13

Flashing/sill tapes, e.g.

EXTOSEAL[®] ENCORS

Waterproof sealing tapes for interior and exterior use

Areas of application:

For creating sub-sill flashing, for sealing window joints with masonry or concrete structures, for sealing wood-based panels to smooth mineral surfaces, for taping underlay panels made of wood fibre to one another (e.g. in roof valleys and transitions), and for sealing these to adjoining structural elements.



Advantages:

- ✓ Excellent protection for building components thanks to strong sealing effect
- ✓ Reliable application: extremely high adhesion even to slightly damp and cold substrates
- ✓ Easy to work with: very elastic - can adapt flexibly to substrates and corners
- ✓ Proven resistance to driving rain up to 2400 Pa
- ✓ Independently confirmed suitability: tests in accordance with MO-01/1 passed at IFT in Rosenheim, Germany
- ✓ Subsequent work can be started quickly: sticks to stable mineral substrates without primers
- ✓ Excellent values in hazardous substance testing, has been tested according to the ISO 16000 evaluation scheme

Many possible applications:



Can be used to create sub-sill flashing.



Very elastic – adapts flexibly to substrates and corners.



Waterproof taping of angle brackets.



Joints between windows and masonry or concrete structures.



Extremely elastic for corner areas.



Other flashing/sill tapes and further information on EXTOSEAL ENCORS

- Detailed CAD drawings
- And much more:

proclima.info/en/flashing-tapes



EXTOSEAL ENCORS
Waterproof sealing tape, for interior and exterior use



EXTOSEAL FINOC
Moisture-sealing adhesive tape, for interior and exterior use



Technical data:

Backing	Elastic PE carrier film
Main product component	Butyl rubber modified with acrylate
Colour	Butyl rubber: grey, film: black
Surface weight	EN 1849-2 1.9 kg/m ² ; 6.23 oz/ft ²
Thickness	EN 1849-2 1.1 mm ; 43 mils
s _p value	EN 1931 > 200 m
Outdoor exposure	6 months
Resistance to driving rain	ift, MO-01/1:2007-01, Abs. 5 600 Pa (ift), sub-sill flashing
Installation temperature	-10 °C to 35 °C ; 14 °F to 95 °F
Temperature resistance	permanent -40 °C to 80 °C ; -40 °F to 176 °F
Storage	cool and dry

Supply forms:

Length: 20 m (65' 5/8"); width: 100 mm (4"); 150 mm (5 7/8"); 200 mm (7 7/8"); 300 mm (11 3/4")

System finder for plaster and window joints – pages 12/13



EXTOSEAL ENCORS



CONTEGA[®] FIDEN EXO

Pre-compressed joint-sealing tape, for exterior use

Areas of application:

For exterior sealing of joints on building structures in a manner that is diffusion-open and resistant to driving rain. This particularly weather-resistant tape has a self-adhesive surface on one side for easy installation.



Advantages:

- ✓ Permanent sealing of joints thanks to extremely high resistance to weathering
- ✓ Fulfils the highest requirements: BG1 quality and fire rating B1, P-NDS04-1001
- ✓ Ensures dry building components: resistant to driving rain and diffusion-open
- ✓ RAL quality-tested installation
- ✓ Large range for all standard joint widths

Many possible applications:



Cut the outer protective film with a utility knife and remove this film.



Roll off a length of CONTEGA FIDEN EXO and cut off the overcompressed start of the tape (approx. 2 cm; 3/4").



Remove the release film, align the tape straight on the frame and gradually stick it in place. The tape must not be visible after installation (allow a recess of approx. 1-2 mm; 1/16").



Allow for a small amount of slack in the tape when sticking it in place, particularly near joints – do not stretch the tape!



Stick the tape all around the window frame. Use a separate length of CONTEGA FIDEN EXO on each side, and use butt-joints at the corners. Allow for a small amount of slack near the corners.



Install the window professionally using a suitable fastening system.



Other window-sealing tapes and further information on CONTEGA FIDEN EXO

- Detailed CAD drawings
- And much more:

proclima.info/en/window-sealing



EXTOSEAL FIDEN EXO
Pre-compressed joint-sealing tape,
for exterior use

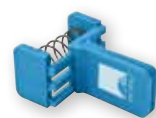

KLIPFIX
Clip for rolls of CONTEGA
FIDEN EXO tape



Technical data:

Main product component	Open-cell polyurethane flexible foam with polymer impregnation
Colour	anthracite
s_d value	< 0.5 m
Fire behaviour	B1, P-NDS04-1001
Joint permeability	$a < 0.1 \text{ m}^3/[(h \cdot \text{m} \cdot (\text{daPa})^n)]$
Loading group	BG1
Weather resistance	passed
Resistance to driving rain	requirements fulfilled up to 600 Pa
Can be plastered/painted over	yes
Compatibility with conventional construction materials	yes
Installation temperature	above +1 °C ; 34 °F
Temperature resistance	permanent: -30 °C to +90 °C ; -22 °F to 194 °F
Storage	1 °C to 20 °C ; 34 °F to 68 °F, 12 months, cool and dry

Supply forms:

Length: 2.6 m (8' 1/2"); 3.3 m (10' 7/8"); 4.3 m (14' 1/8"); 5 m (16' 3/8"); 8 m (26' 1/4"); 10 m (32' 3/4"),
Width: 10 mm (3/8"); 12 mm (1/2"); 15 mm (7/16"); 20 mm (7/8")



System finder for plaster and window joints – pages 12/13

Liquid sealants

AEROSANA VISCONN

Sprayable airtightness sealant with humidity-variable water vapour permeability, blue/black

Areas of application:

For use as a humidity-variable vapour check and airtight layer that can be applied as a spray or using a brush on wall, ceiling and floor surfaces, such as non-plastered masonry or porous panel-form materials – both indoors and outdoors. Also suitable for building component joints and for strengthening subsurfaces on renovation projects.



Advantages:

- ✓ Time-saving and can be applied in versatile ways: spraying with an airless sprayer or AEROFIXX (compressed air), paint on.
- ✓ Reliable structures thanks to excellent adhesive properties on all standard construction surfaces
- ✓ Covers cracks and joints of up to 3 mm (1/8") width. Larger joints can also be covered in combination with AEROSANA FLEECE.
- ✓ For robust building components: permanent elasticity and high durability once it has dried
- ✓ Improves surfaces: forms a bonding course between subsurfaces and subsequent coatings
- ✓ Can be plastered / painted over, pro clima adhesive tapes can be stuck onto it
- ✓ Flexible use in indoor and protected outdoor areas thanks to its humidity-variable s_d value
- ✓ Excellent values in hazardous substance testing, has been tested according to the ISO 16000 evaluation scheme

Many possible applications:



Airtight spraying over angle brackets,



... joints at double collar ties that are difficult to access,



... joints between wood-based panels,



... window joints,



... unplastered walls, and



... for challenging refurbishment situations.



Other liquid sealants and further information on AEROSANA VISCONN

- Installation videos
- Detailed CAD drawings
- And much more:

proclima.info/en/liquid-seals



AEROSANA VISCONN
Sprayable airtightness sealant with humidity-variable water vapour permeability, blue/black



AEROSANA VISCONN white
Sprayable airtightness sealant with humidity-variable water vapour permeability, white



AEROSANA VISCONN FIBRE
Fibre-reinforced sealant with humidity-variable water vapour permeability, blue/black



AEROSANA VISCONN FIBRE white
Fibre-reinforced sealant with humidity-variable water vapour permeability, white



AEROSANA FLEECE
Fleece for covering cracks or joints



AEROFIXX
Application gun for AEROSANA system foil cartridges



Technical specs:

Component		Modified aqueous acrylate polymer dispersion
Colour		dark blue, when fully dry dark blue/black
Surface weight	EN 1849-2	290 g/m ² ; 0.95 oz/ft ² (dried, at 0.3 mm ; 13 mil thickness)
Coating application		0.2 - 1.0 mm ; 8 - 39 mil - wet film
s_d value / humidity variable	EN 1931 / EN ISO 12572	6 m (at 0.3 mm ; 13 mil thickness) / 0.13 - 10.00 m
g value / humidity variable	EN 1931 / EN ISO 12572	30 MN·s/g (at 0.3 mm ; 13 mil thickness) / 0.65 - 50 MN·s/g
Fire rating	DIN EN 13501-1	E
Outdoor exposure		3 months
Resistance to driving rain	ift, MO-01/1:2007-01, Abs. 5	up to 600 Pa, around window
Watertightness to liquid water	EN 1928	W1
Water column	EN ISO 811	2 000 mm ; 6' 7"
Airtightness	ift, MO-01/1:2007-01, Abs. 5	up to 1000 Pa, around window
Can be plastered / painted over		yes, and pro clima adhesive tapes can be stuck onto it
Durability after artificial ageing		passed
Application temperature		+5 °C to +60 °C; 40 °F to 140 °F (also applies to subsurface temperature)
Drying		approx. 12 - 48 hours (at 20 °C, 65% rel. humidity) depending on subsurface and applied thickness
Temperature resistance		permanent -40 °C to +90 °C ; -40 °F to +194 °F (dried)
Coverage		~ 1.33 m ² /l ; 0.42 ft ² /US fl oz (= 0.75 l/m ² ; 2.36 US fl oz/ft ²), depending on subsurface and application method
Storage		5 °C to 25 °C ; 41 °F to 77 °F, closed in an airtight manner

Supply forms:

AEROSANA VISCONN /white: 10 litres (2.64 US gallons) tin, 0.6 litres (20.3 US fl oz) foil cartridge;
AEROSANA VISCONN FIBRE /white: 5 litres (1.32 US gallons) tin, 0.6 litres (20.3 US fl oz) foil cartridge

System finder for plaster and window joints – pages 12/13



AEROSANA VISCONN

Joint adhesives, e.g.

ORCON[®] F

All-round joint adhesive for interior and exterior use

Areas of application:

Permanent, elastic joint adhesive. For sealing all types of vapour checks and vapour barriers – e.g. pro clima INTELLO, PE, PA, PP and aluminium sheeting, and underlay and breather membranes – to adjacent building components.



Advantages:

- ✓ Reliable adhesion even during frosty conditions: can be worked with above -10 °C (14 °F)
- ✓ Particularly durable: adhesion for 100 years, independently tested and confirmed
- ✓ Ensures firm and permanently elastic adhesion
- ✓ Ensures reliable joints: penetrates deep into the subsurface, remains elastic
- ✓ Test winner in April 2012 with the German product-testing foundation 'Stiftung Warentest'
- ✓ Construction in adherence with standards: for airtight sealing in accordance with DIN 4108-7, SIA 180 and RE 2020
- ✓ Can be stored down to -20 °C (-4 °F). Material does not freeze in the tube
- ✓ Excellent values in hazardous substance testing, has been tested according to the ISO 16000 evaluation scheme

Many possible applications:



Joint adhesive for interior airtightness membranes,



... for exterior windtightness membranes,



... for vapour checks underneath external roof insulation,



... for vapour checks on refurbishment projects,



... and floor joints with wood-based panels,



... e.g. with INTELLO conneX



Other joint adhesives and further information on ORCON F

- Detailed CAD drawings
- And much more:

proclima.info/en/joint-adhesives



ORCON F
All-round joint adhesive for interior and exterior use



ORCON CLASSIC
Solvent-free all-round joint adhesive for interior and exterior use

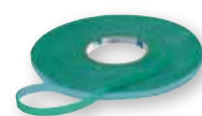

ORCON MULTIBOND
Rolls of joint adhesive for interior and exterior use



ECO COLL
Natural latex adhesive for interior use



Technical data:

Main product component	Dispersion based on acrylic acid copolymers and ethanol. Free from plasticisers, halogens
Colour	green
Characteristics	high elasticity
Bond durability, non-aged/aged	DIN 4108-11 passed
Installation temperature	-10 °C to 50 °C ; 14 °F to 122 °F
Temperature resistance	permanent -40 °C to 80 °C ; -40 °F to 176 °F
Storage	down to -20 °C ; -4 °F , cool and dry

Supply forms:

Contents: 310 ml (10.5 US fl oz) in cartridges; 600 ml (20.3 US fl oz) in foil tubes



Primers, e.g.

TESCON® SPRIMER

Sprayable primer for interior and exterior use

Areas of application:

For preparation and stabilisation of subsurfaces for subsequent application of pro clima adhesive tapes such as TESCON VANA, TESCON PROTECT and sealing tapes in the EXTONSEAL series. Suitable for wood, wood-fibre boards, masonry, roofs, walls and ground slabs. Also suitable for building component joints and for stabilising subsurfaces on renovation projects.



Advantages:

- ✓ Easy to apply: spray on directly from the can, no contamination of the primer in its container
- ✓ Secure bonds: penetrates deep and strengthens dusty subsurfaces or subsurfaces with insufficient stability
- ✓ Saves time: adhesive tapes can be stuck to absorbent subsurfaces with no drying time necessary
- ✓ Flexible use: can be used on dry and slightly moist subsurfaces
- ✓ At any time of the year: can also be applied during frosty conditions

Many possible applications:



Use on wood-fibre underlay panels



... wood-based panels and mineral subsurfaces



and on old timber.



Adjustable spray jet: horizontal or vertical.



Tapes can be stuck directly onto recently applied primer.



The primer strengthens unstable subsurfaces.



Technical data:

Main product component	Synthetic rubber
Colour	translucent
Installation temperature	-5 °C to 40 °C ; 23 °F to 104 °F
Temperature resistance	permanent -25 to ~90 °C; -13 to ~195 °F, short-term up to 100 °C; 212 °F (1h)
Storage	12 months, protect from frost, cool and dry

Supply forms:

Spray cans: 0.4 (13.5 US fl oz); 0.75 litres (25.4 US fl oz)



Other primers and further information on TESCON SPRIMER

- Detailed CAD drawings
- And much more:

proclima.info/en/primers



TESCON SPRIMER
Sprayable primer for interior and exterior use



TESCON PRIMER RP
Solvent-free primer for interior and exterior use



TENAPP
Application tool for primer in 1 litre dispenser bottles

Perfectly sealed window joints made easy

No matter how small your window joints may be, it is still extremely important to plan your installation carefully in advance and then to implement it carefully too. This process can be considered in terms of the following steps:

Planning phase

1. Type of construction, wall structure, analyse statics and determine the window position, assessment of installation situation on site if necessary

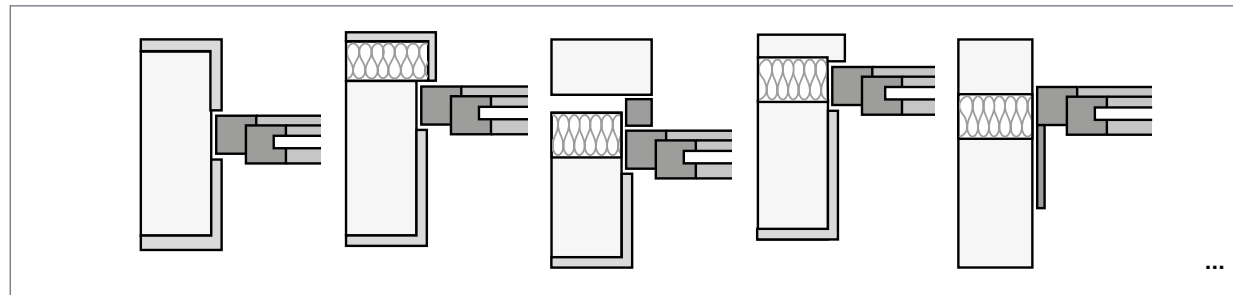

2. Specify the window structure

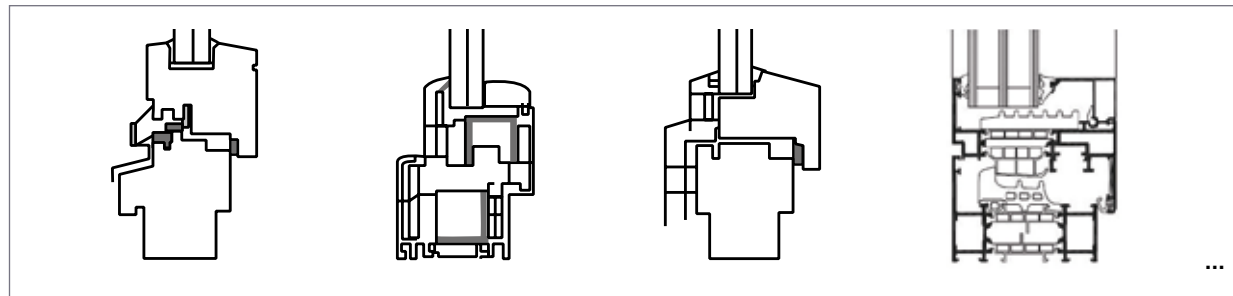

3. Specify the window type

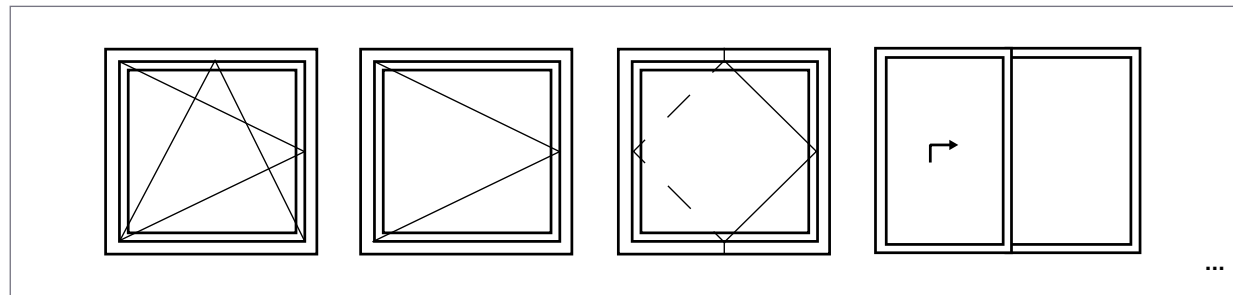

Installation phase

Considering a scenario with a tilt-and-turn window made of plastic, installation flush on the outside, masonry with thermal insulation composite system, new-build project with directly plastered window reveal.

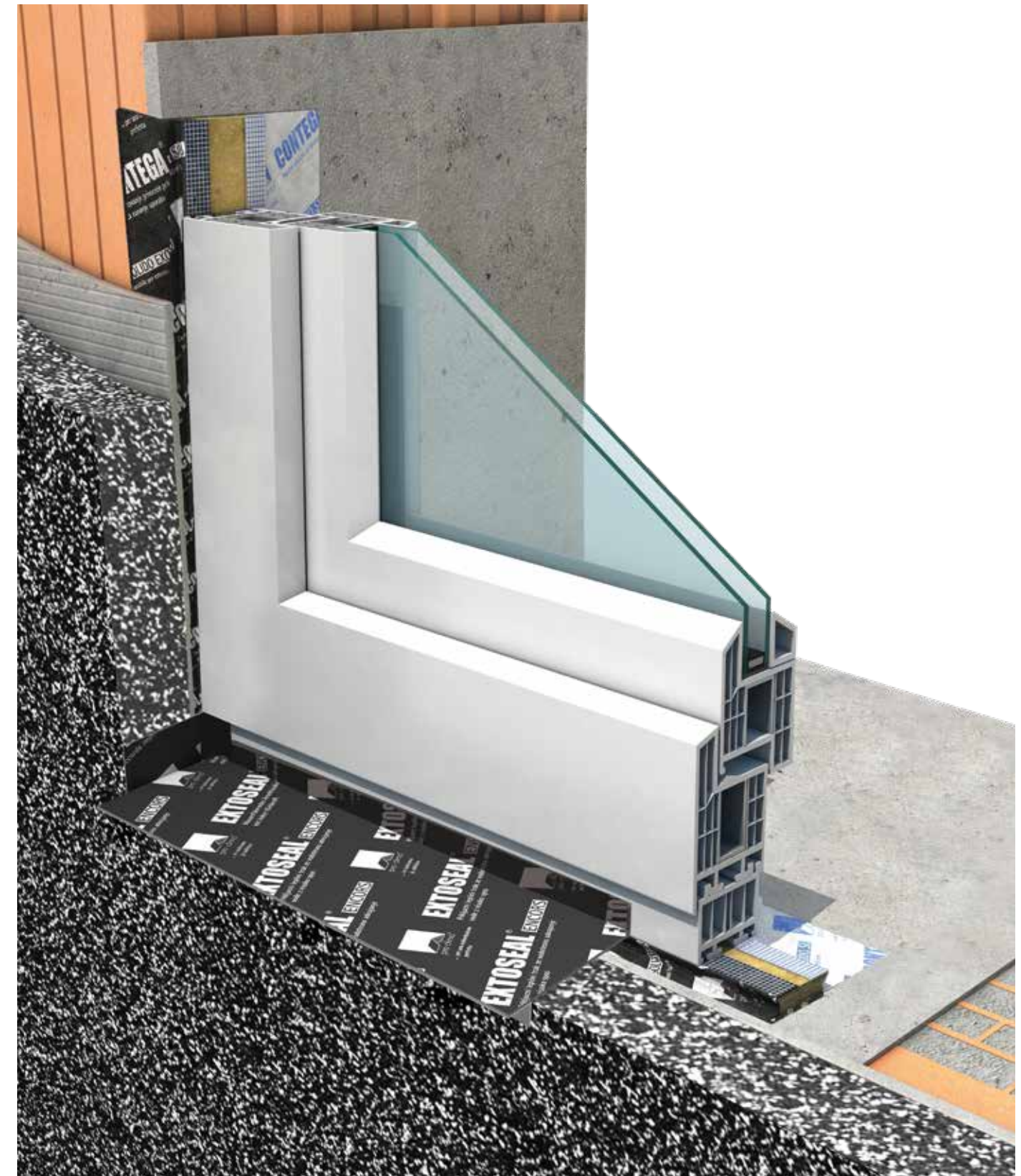

Check the subsurface

Example: Tilt-and-turn window made of plastic, installation flush on the outside, masonry with thermal insulation composite system, new-build project with directly plastered window reveal.

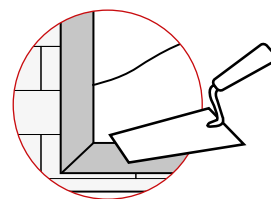
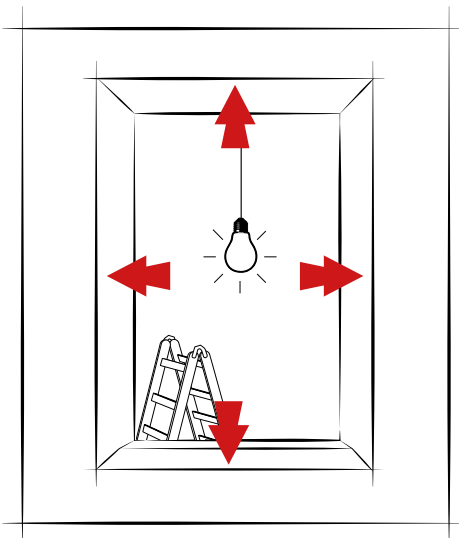

A smooth plaster finish must be present

Check the state of the subsurface

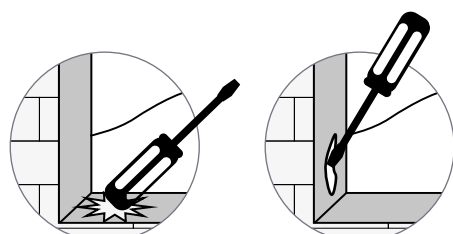

Tap surface carefully

Try to rub surface



Free of frost

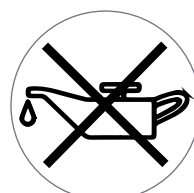

Free of grease and oil



Clean / brush off

Note
Joints at corners, clip-on profiles, wideners and covering strips are to be carried out in a manner that is airtight and/or resistant to driving rain. Open ends can be closed off with EXTONSEAL ENCORS.

Practical tip
Stick CONTEGA window-sealing tapes to the frame before installing the window: simple application of the adhesive tape – reliable sealing – valuable time saved!

Preparation for interior airtightness

1. Clean the perimeter of the window frame

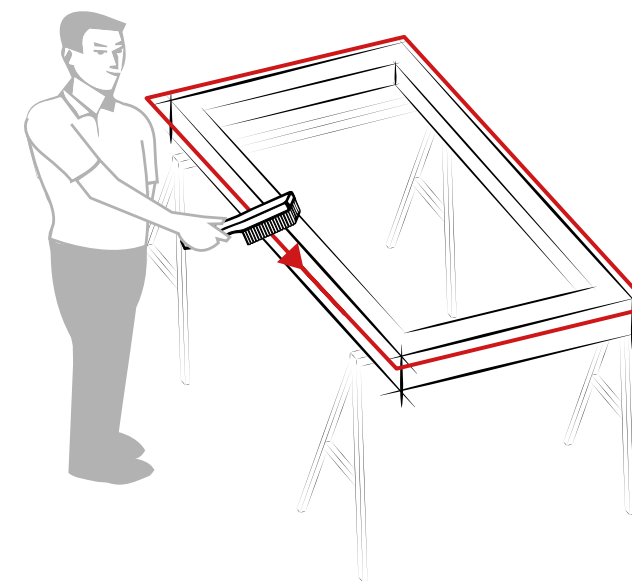

2. Stick CONTEGA SOLIDO SL onto the interior side of the frame

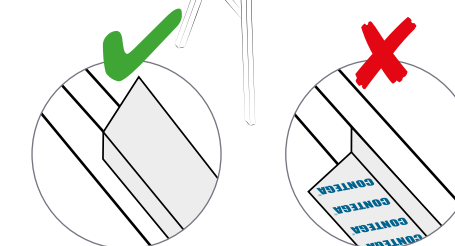
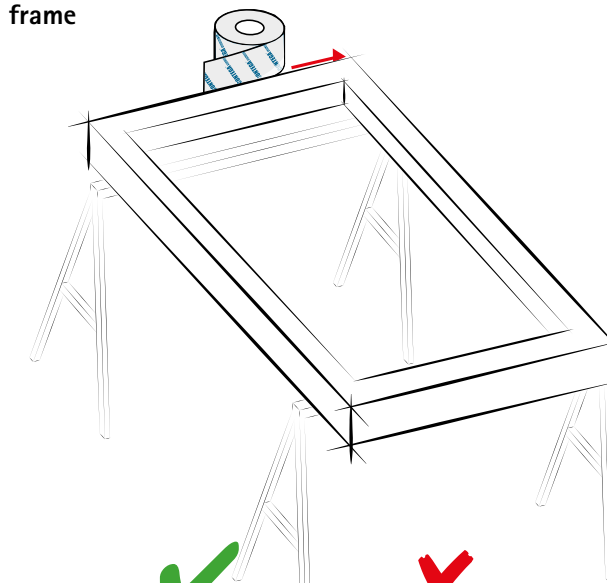

3. Create loops of slack at the corners

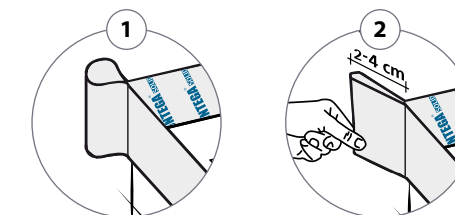
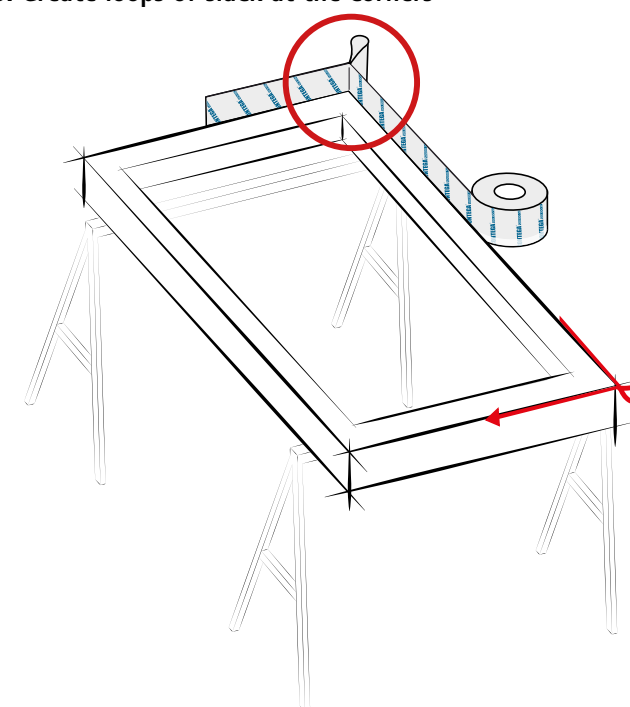

Note:
Why create slack loops at the corners? This is done so that the tape can then be folded out again at the reveal corners after the window has been inserted and can be stuck in a secure, airtight manner. The corner slack should be at least 4 cm (1 5/8"), i.e. approx. double the joint width.



CONTEGA SOLIDO SL
Full-surface adhesive plaster/
window-sealing tape that can be
plastered over, for interior use



CONTEGA
SOLIDO SL

4. Stick CONTEGA SOLIDO SL around the perimeter of the frame

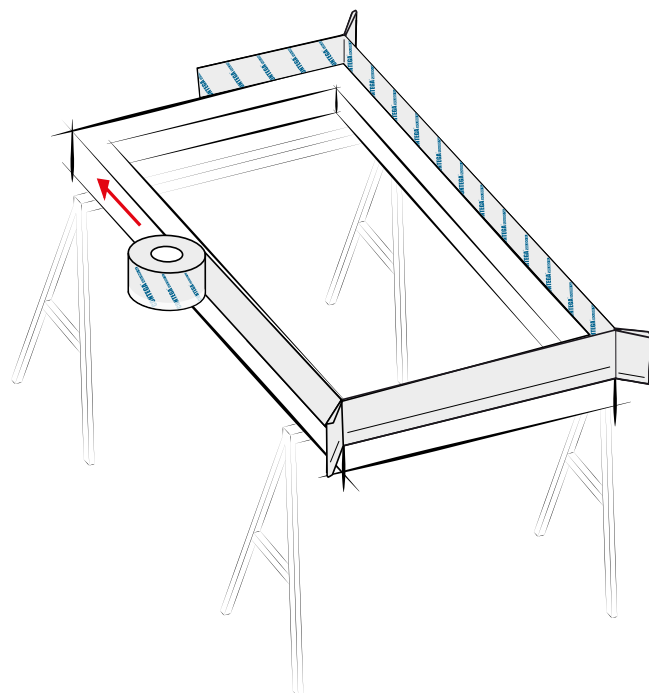

5. Stick the ends

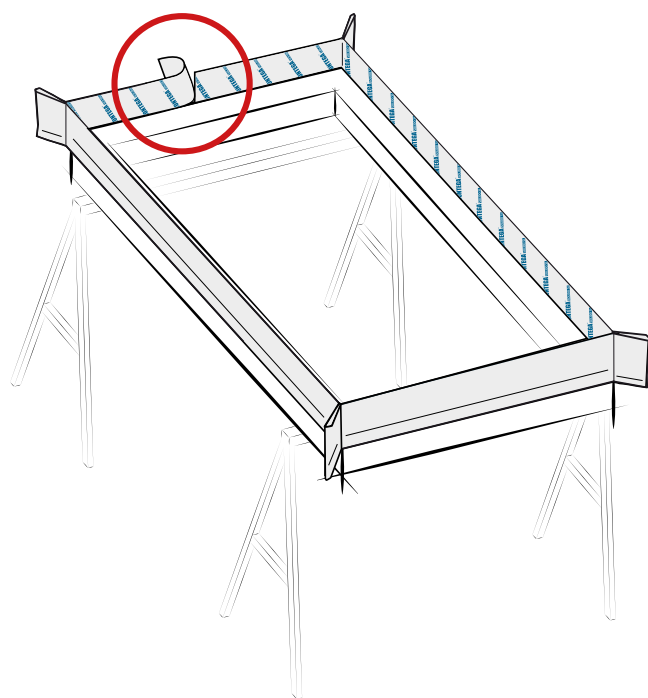

6. Press firmly to secure the adhesive tape

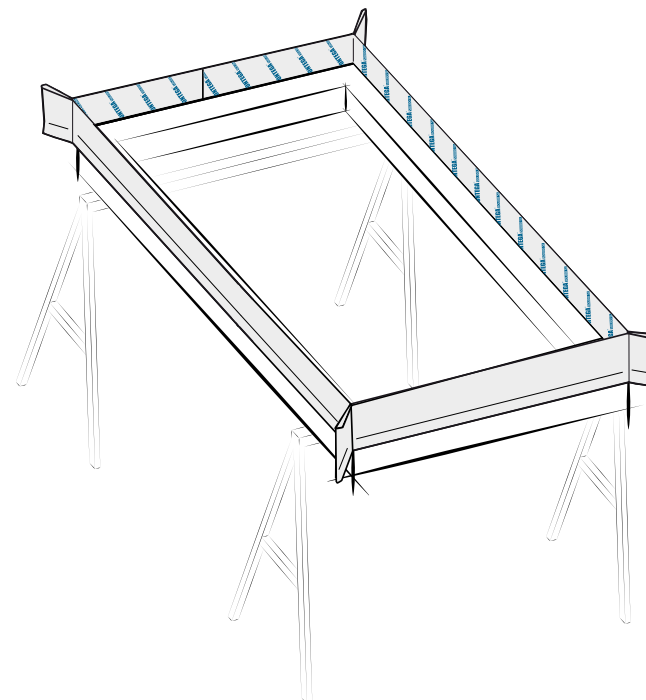

Remove the release film completely and stick in place with approx. 2-5 cm (7/8"-2") of an overlap. Rub using the PRESSFIX application tool to secure.

7. Window frame on the interior side

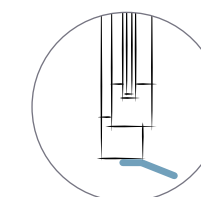
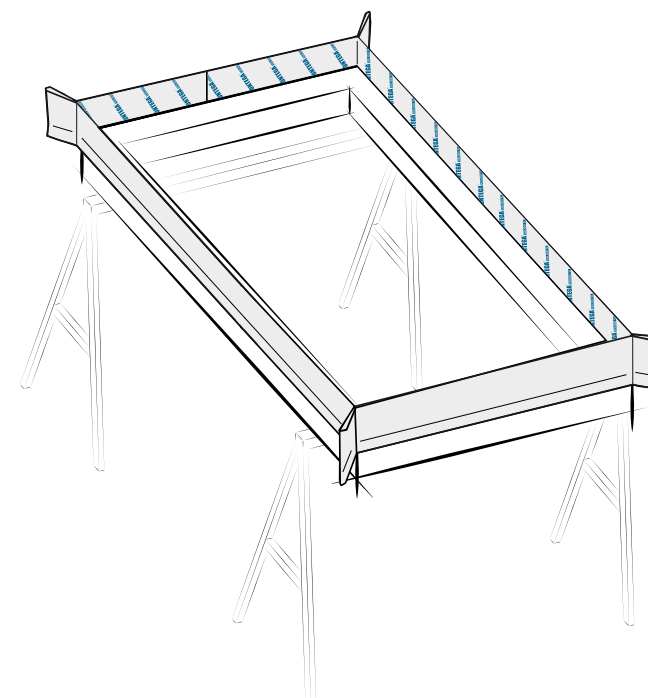

You're finished!



PRESSFIX
Pressing aid for pro clima adhesive tapes

+ **Practical tip**
Hold the tape in place temporarily with removable adhesive tape to make it easier to slide the window into the window opening.

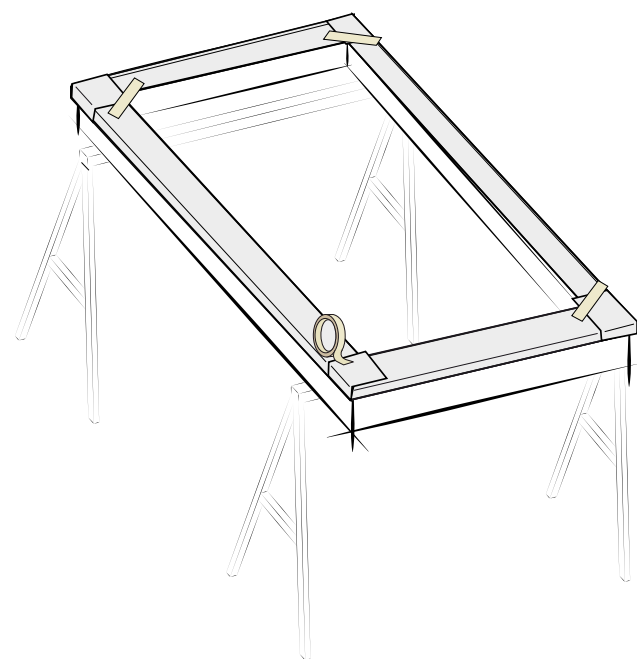
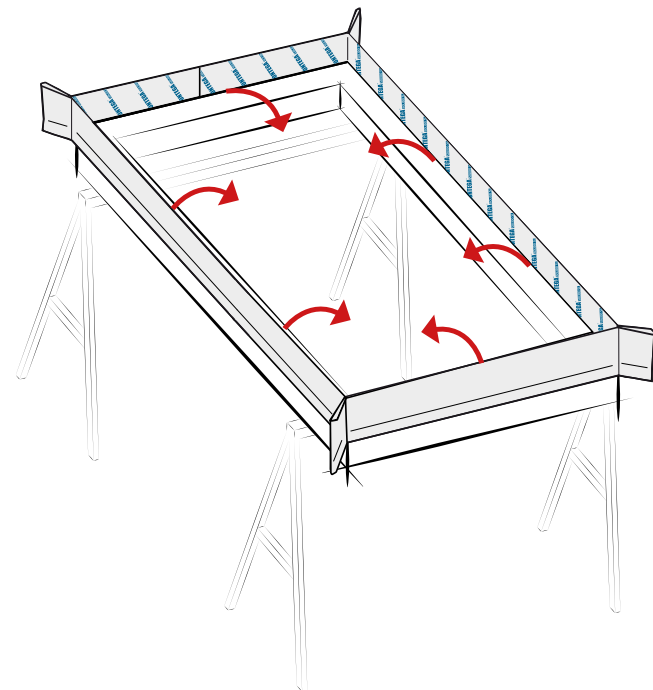

Removable adhesive tape

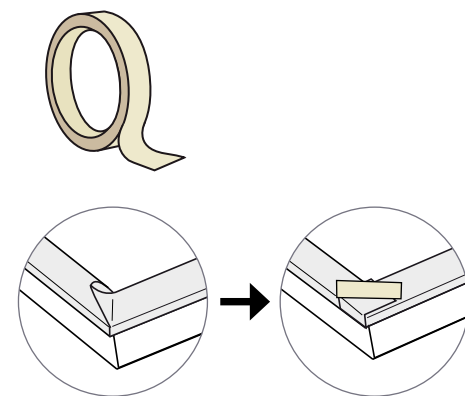

Preparation for exterior weather protection

1. Turn the frame over

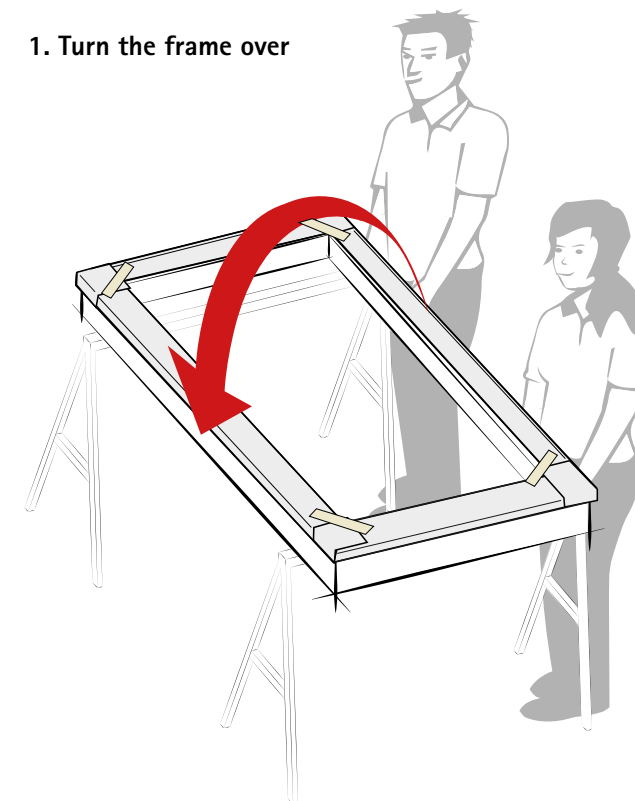

2. Stick CONTEGA SOLIDO EXO-D onto the exterior side of the frame

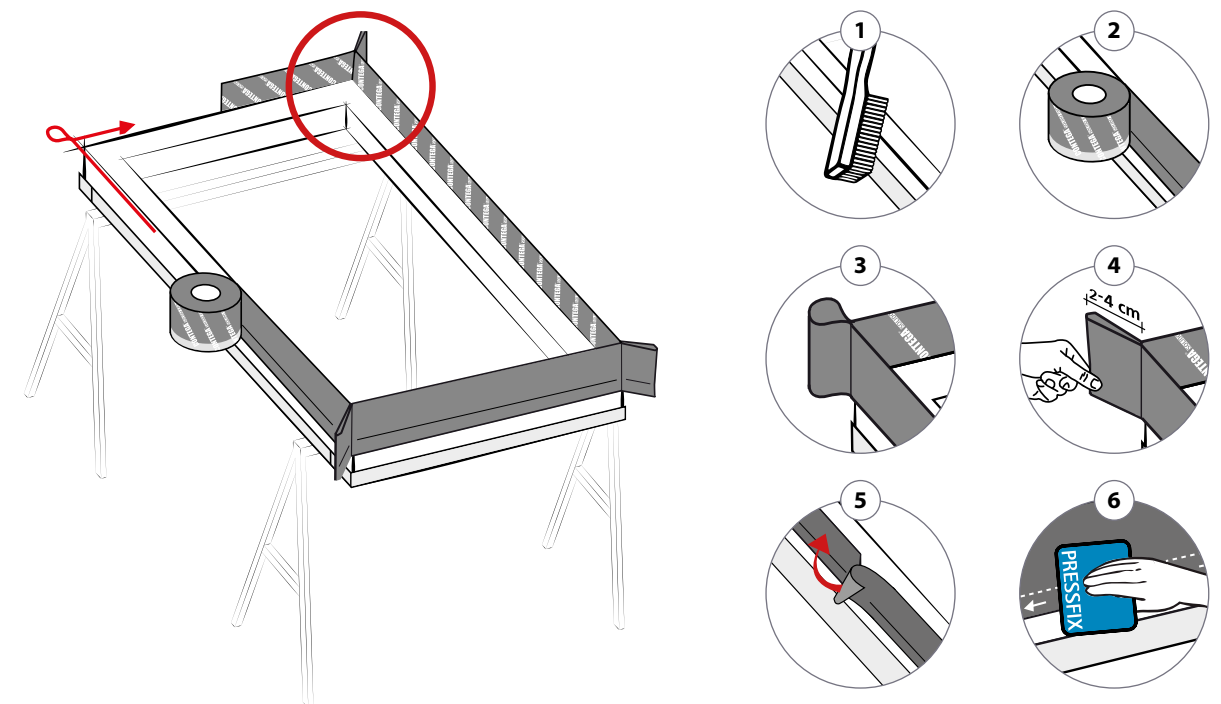

CONTEGA SOLIDO EXO-D
Full-surface adhesive plaster/
window-sealing tape, for exterior use
with an additional adhesive zone



CONTEGA SOLIDO EXO-D

Product variant

with CONTEGA SOLIDO IQ-D

Just one tape for interior and exterior use: Humidity-variable s_d value for dry window joints. One tape for inside and outside means easier stock management too!

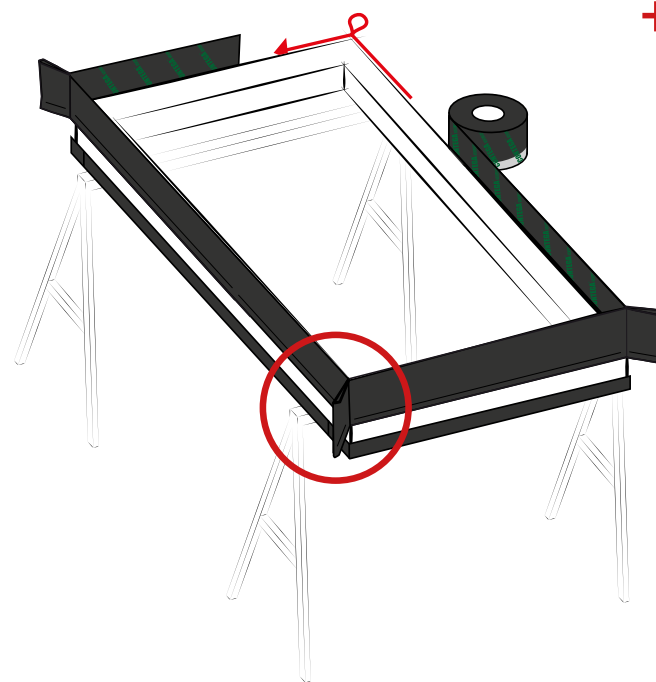
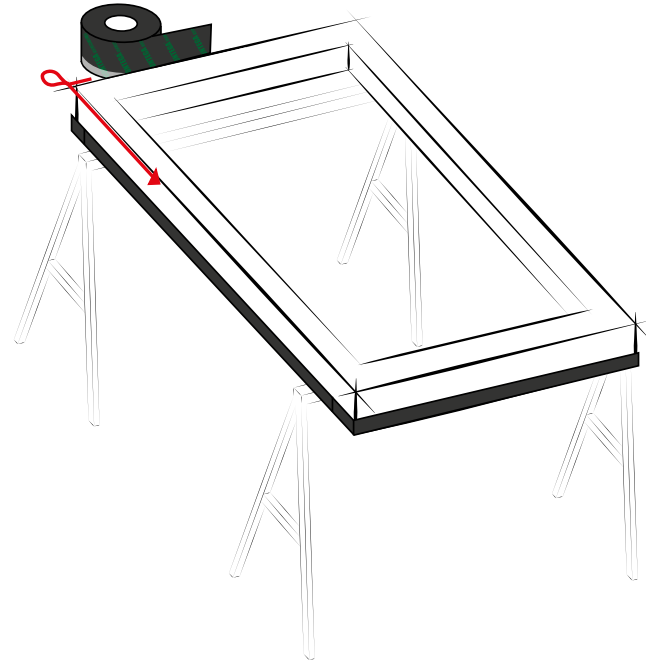

Note
Why create slack loops at the corners? This is done so that the tape can then be folded out again at the reveal corners after the window has been inserted and can be stuck in a secure, airtight or windtight manner. The corner slack should be approx 2-4 cm (7/8"-1 5/8"), i.e. approx. 1.5 times the joint width.

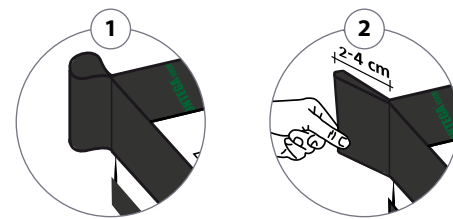

CONTEGA SOLIDO IQ-D
Intelligent full-surface adhesive plaster/window-sealing tape with additional adhesive zone, for interior and exterior use

Just one tape for interior and exterior use: Humidity-variable s_d value for dry window joints. One tape for inside and outside means easier stock management too!



CONTEGA SOLIDO IQ-D

Installation of sub-sill flashing

1. Cut EXTONSEAL ENCORS to size, allowing for excess

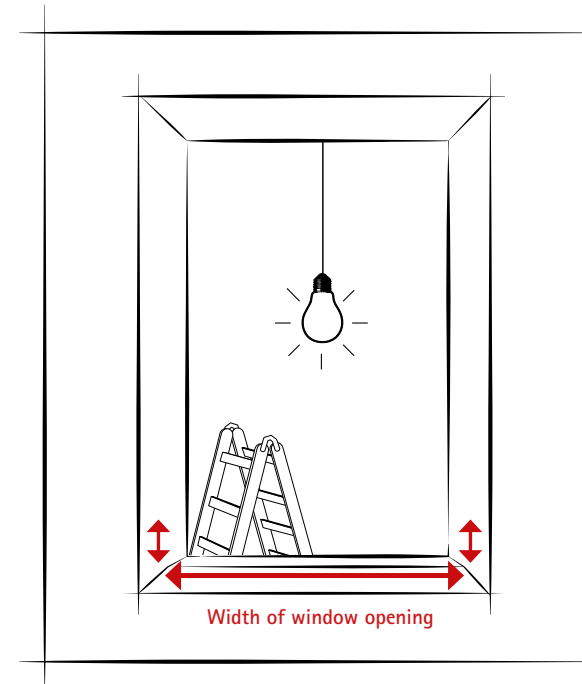

+ Allow for an additional length of tape for the reveal sides, depending on the subsequent installation procedure:

- approx. 6 cm (2 3/8") for a directly plastered window reveal.
- approx. 10-15 cm (4" to 6") for rear-ventilated structures or other material layers (take capillary suction into account for approx. 10 cm [4"])

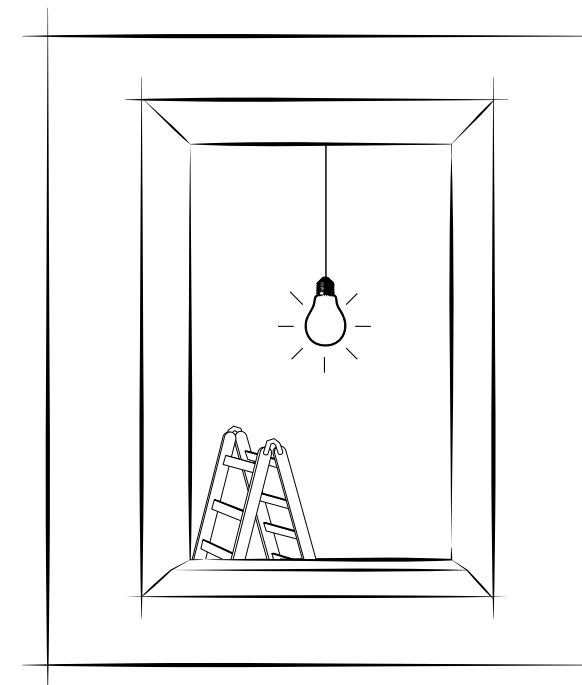

+ **Practical tip: Install an insulation wedge**
An insulation wedge can be used to create an inclined run-off, and to help avoid thermal bridges.



EXTONSEAL ENCORS
Waterproof sealing tape, for interior and exterior use



EXTONSEAL ENCORS

2. Remove the wide release film and stick EXTONSEAL ENCORS onto the window sill

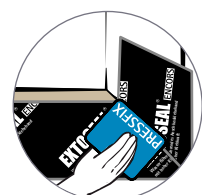
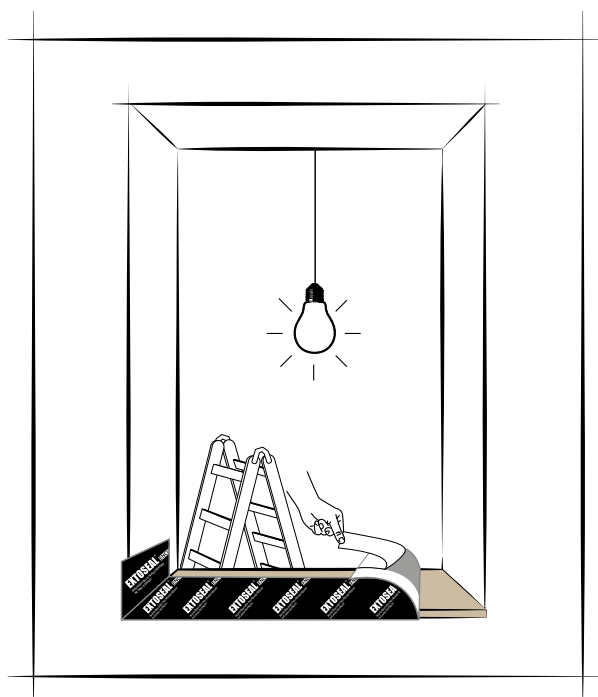

Stick to the reveal sides

Note
 Guide the EXTONSEAL ENCORS tape right into the corners and rub firmly into place. Select the width of EXTONSEAL ENCORS so that it protrudes behind the vertical window profile by at least approx. 2 cm (7/8"). Lengths of tape can be stuck together with an overlap of approx. 2-3 cm (7/8"-1 3/16") to create larger areas.

3. Cut off excess tape at window reveals

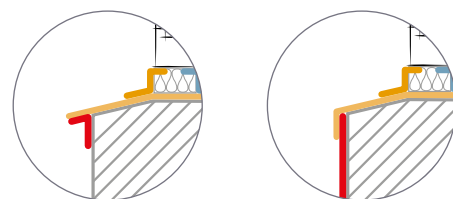
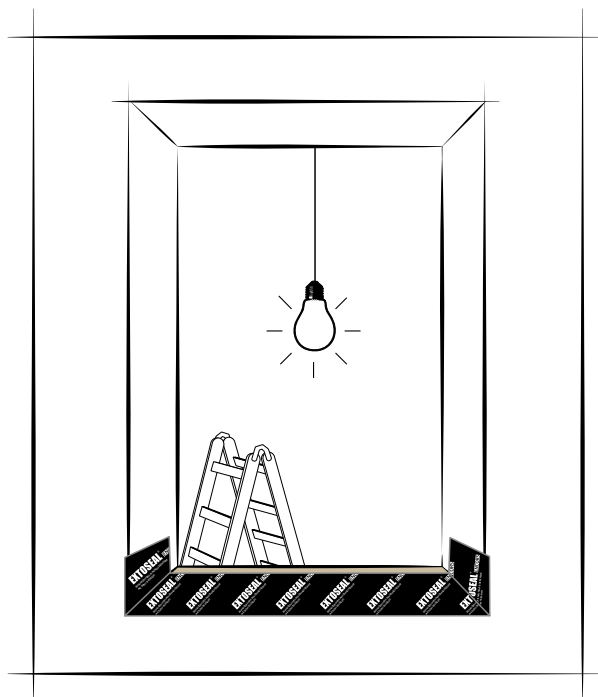

Depending on the type of facade used, EXTONSEAL ENCORS is continued onto a drip profile or a facade membrane.

Practical tip
 Installation is easier if the side with the narrow release film protrudes on the outside. EXTONSEAL ENCORS can be installed with full-surface adhesion as a temporary protection measure during the construction period.

4. Stick EXTONSEAL ENCORS in place

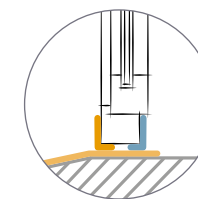
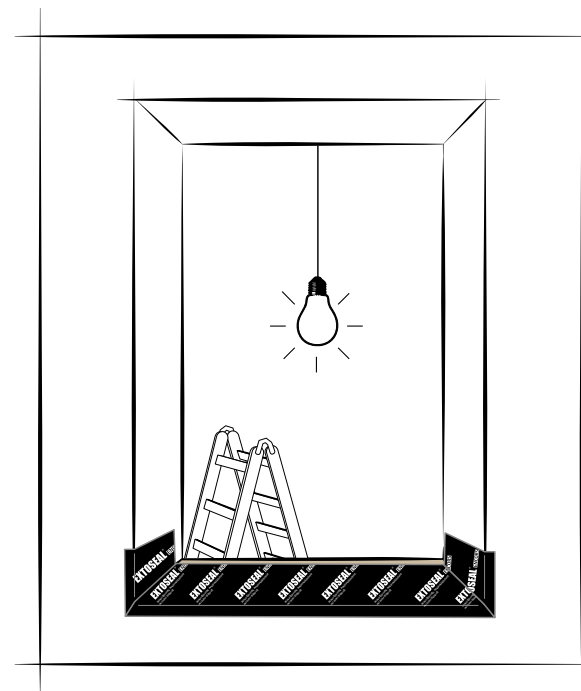

You're finished!

Note
 Guide the EXTONSEAL ENCORS tape right into the corners and rub firmly into place. EXTONSEAL ENCORS cannot be plastered over: fit a reveal plate before plastering, or else tape over with TESCON VANA and add suitable reinforcement to the plaster. In this example, EXTONSEAL ENCORS is shown as sub-sill flashing as part of a rear-ventilated system. In the case of a thermal insulation composite system (TICS), installation of the sub-sill flashing should be adapted as necessary.

Install the window

1. Install the window professionally

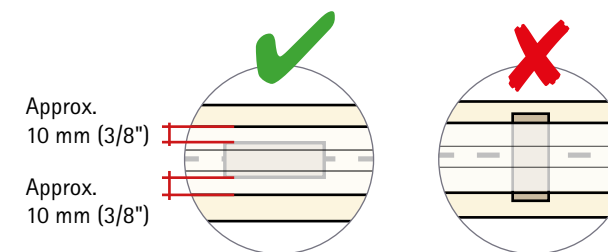
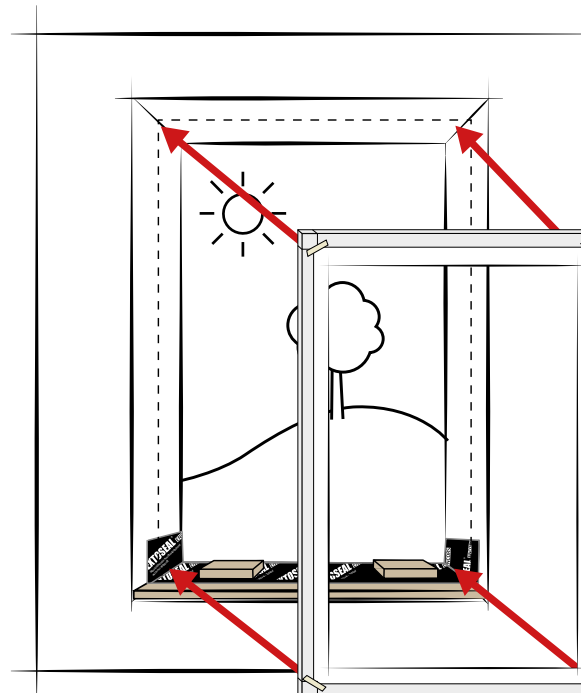

Approx. 10 mm (3/8")
 Approx. 10 mm (3/8")

Note
 Use setting blocks made of hardwood or plastic (they must be pressure-resistant and keep their shape). They must not protrude beyond the frame.

2. Install the window professionally

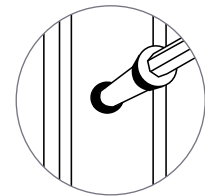
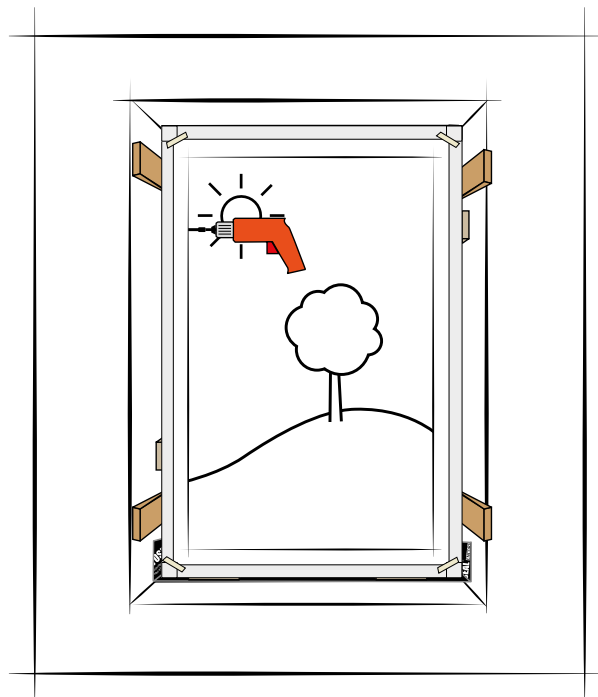

Fasten the window using a suitable fastening system

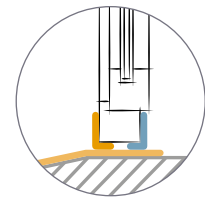

You're finished!

+
Practical tip
Should you start sealing inside or outside? Decide based on the on-site situation, such as weather conditions or the stage of progress of construction – this decision does not depend on the pro clima window-sealing tapes.

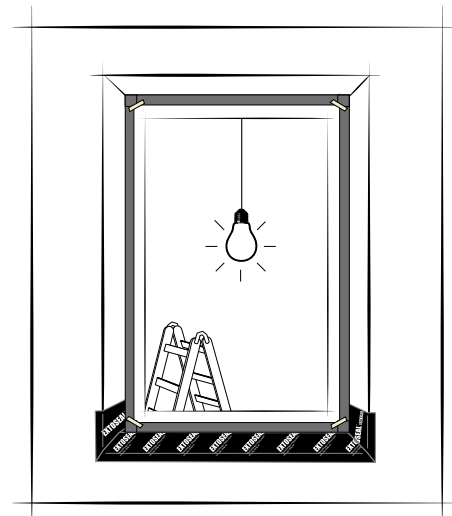
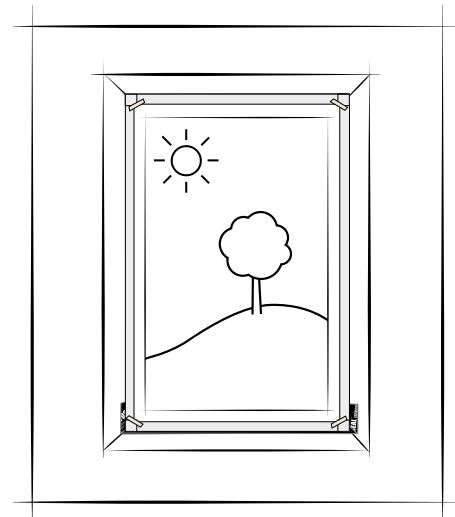

Installing the interior airtightness sealing

1. Stick the tape all around the reveal

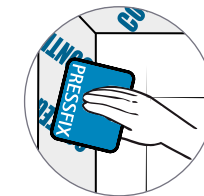
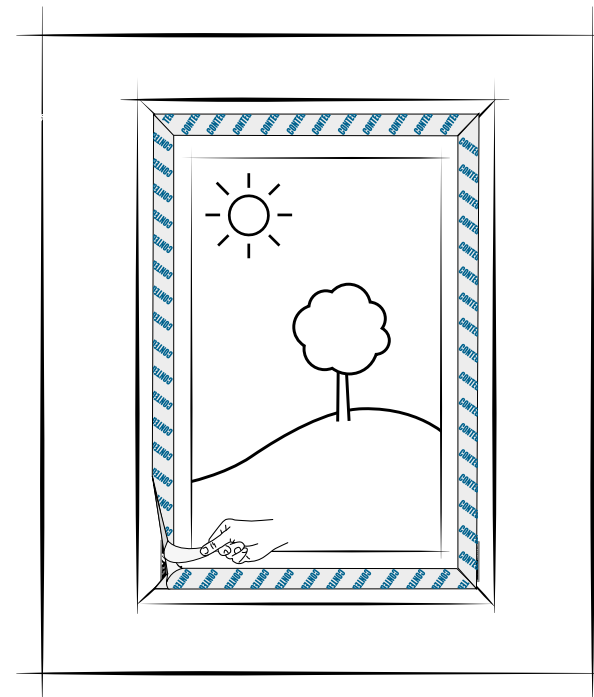

Rub in place using the PRESSFIX tool

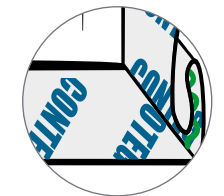

Use ORCON F adhesive at the corners if necessary

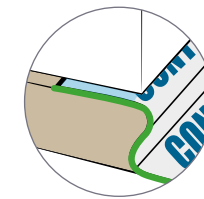

+
Note
Apply the tape with slack to allow for movement.

3. Interior airtightness: finished

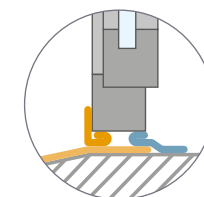
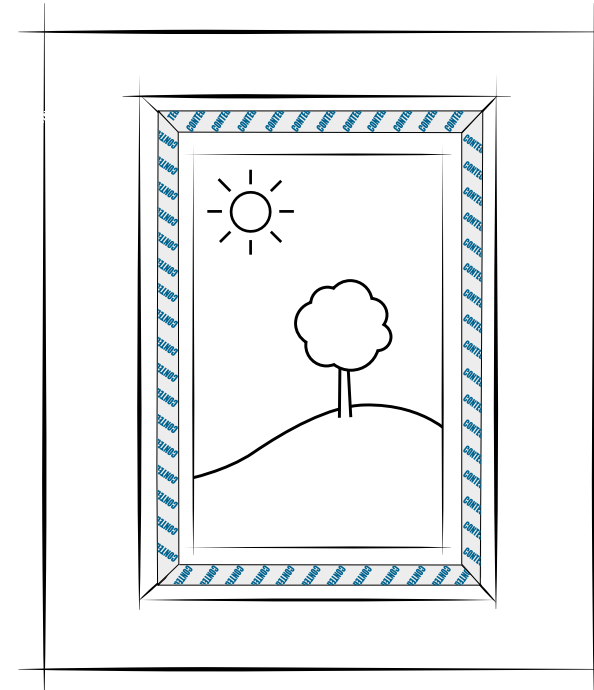

You're finished!

Insulating the joint

1. Fill the joint with insulation material

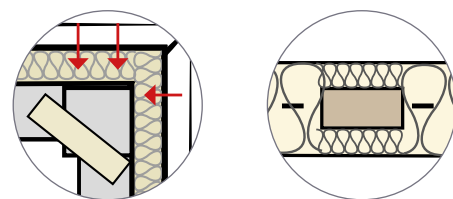
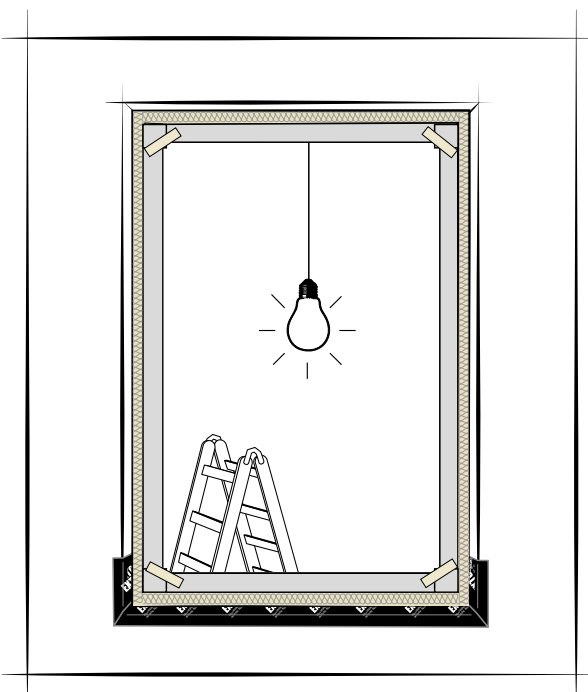

Fill the joint with insulation material around the perimeter, leaving no cavities

Insulate over setting blocks

+ **Practical tip**
Folding over the window-sealing tape in advance will make it easier to insert the insulation. Install the insulation material around the profile, leaving no cavities, before applying the tape. This makes it easier to carry out adhesion work on the interior and exterior sealing layers.

2. Exterior weather protection: finished

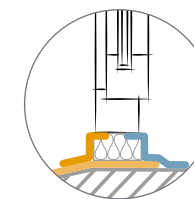
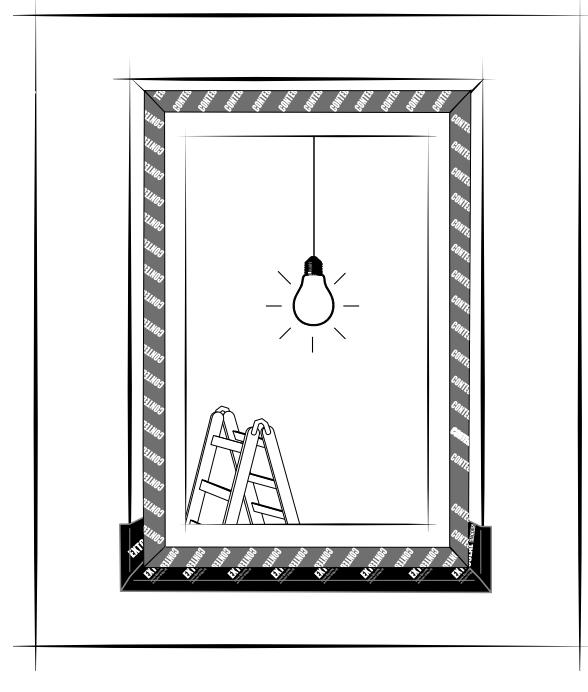



You're finished!

+ **Note**
Install endpieces of window sills in such a way that they can be finished to be flush with the outer plaster layer. This prevents standing water from collecting on the top surface. Seal off any fasteners.

Installing exterior weather protection

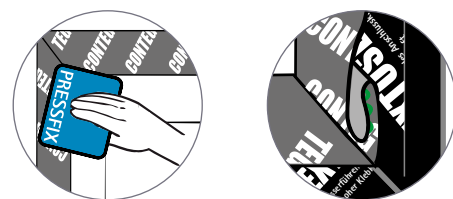
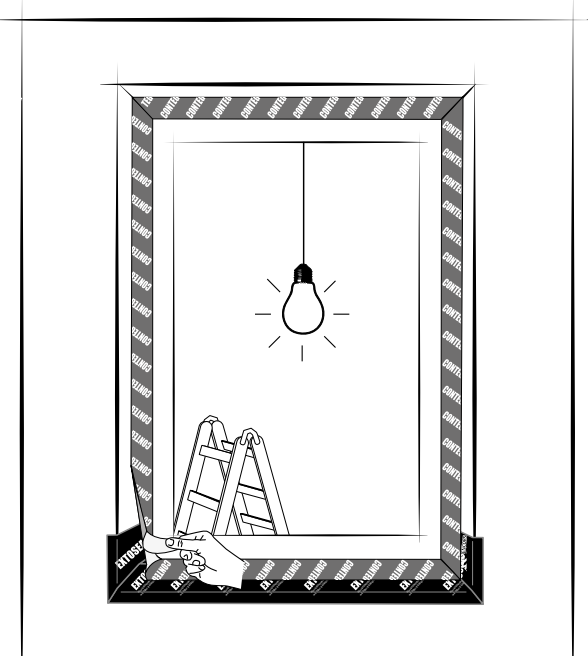
1. Stick the tape all around the reveal



Rub in place using the PRESSFIX tool

Use ORCON F adhesive at the corners if necessary

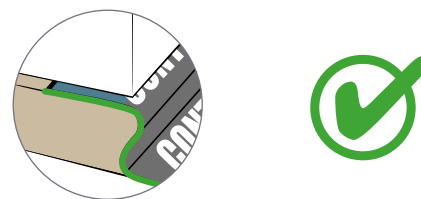

Apply the tape with slack to allow for movement

+ **Note**
Adhesive joints that are resistant to wind and driving rain can only be achieved if the sealing tape is installed free of folds and breaks.

Remove the release film

Installation in front of the wall

Installation steps: Externally mounted windows

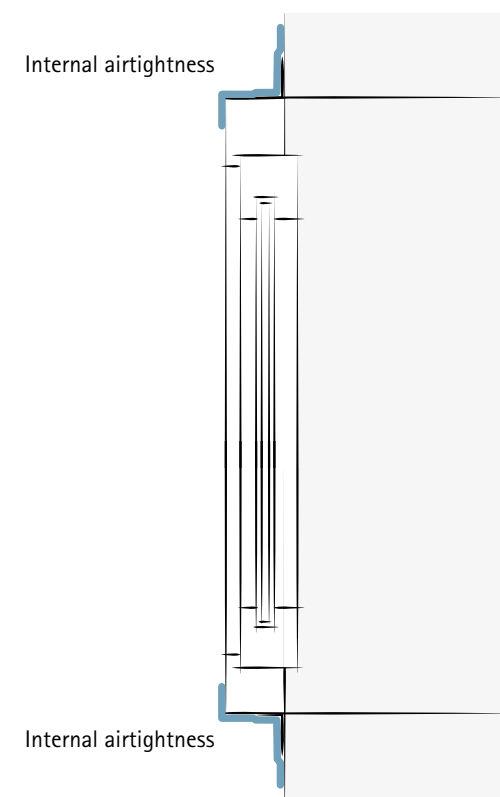

1. Cut the tape to size

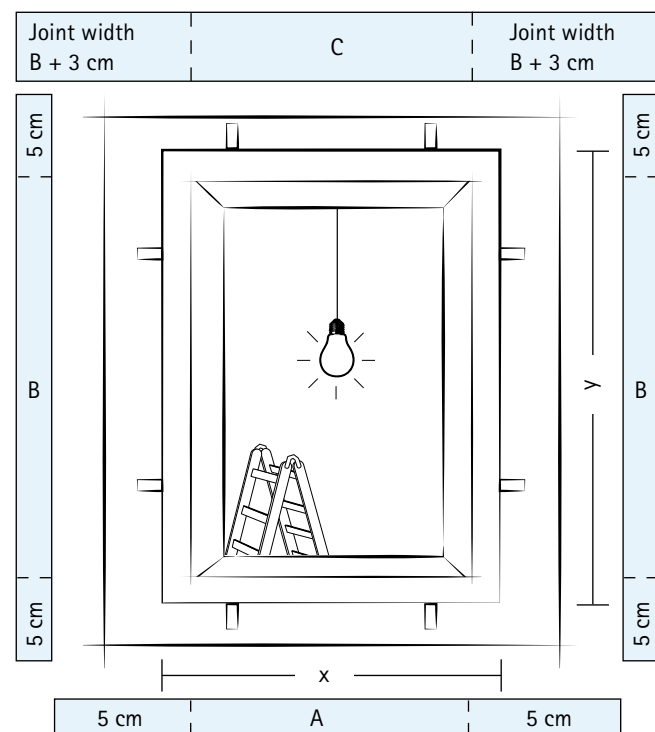

Note
 $A = x + 5 \text{ cm (2")} + 5 \text{ cm (2")}$
 $B = y + 5 \text{ cm (2")} + 5 \text{ cm (2")}$
 $C = x + \text{double the side joint width} + 3 \text{ cm (1 3/16")}$

Select the tape width so that a width of 5 cm (2") is covered by the tape on the concrete/masonry. CONTEGA SOLIDO IQ should cover a width of at least 5 cm (2") on the concrete/masonry in the area around brackets/anchors. When cutting CONTEGA SOLIDO IQ to length for the joints around the window, $2 \times 5 \text{ cm (2")}$ should be added to the frame dimensions for the lower and side tape lengths to allow for corner overlaps. The joint created at the top must completely cover the width of the taped joints at the sides. If the adhesive joints are created using a number of shorter lengths of tape for a particular side, the tape overlap must always be at least 3 cm (1 3/16") at tape joints.

2. Tape over brackets

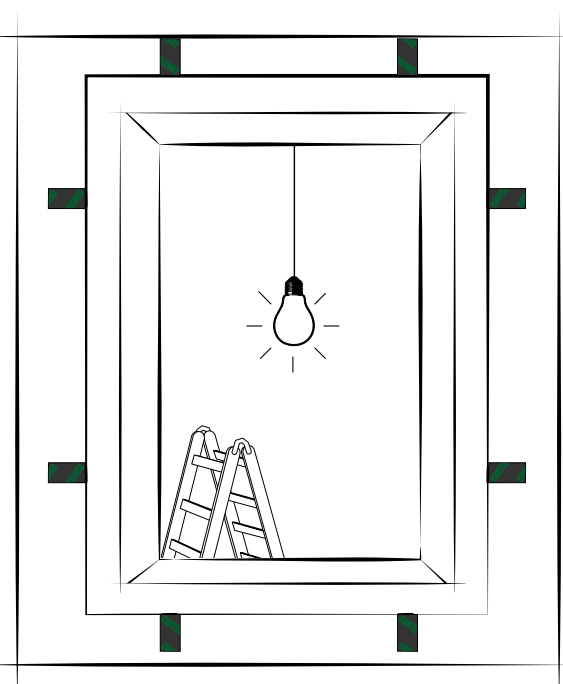

Note
 Brackets should be taped in such a way that a minimum width of approx. 5 cm (2") is achieved for adhesion to the subsurface.

3. Stick to the window

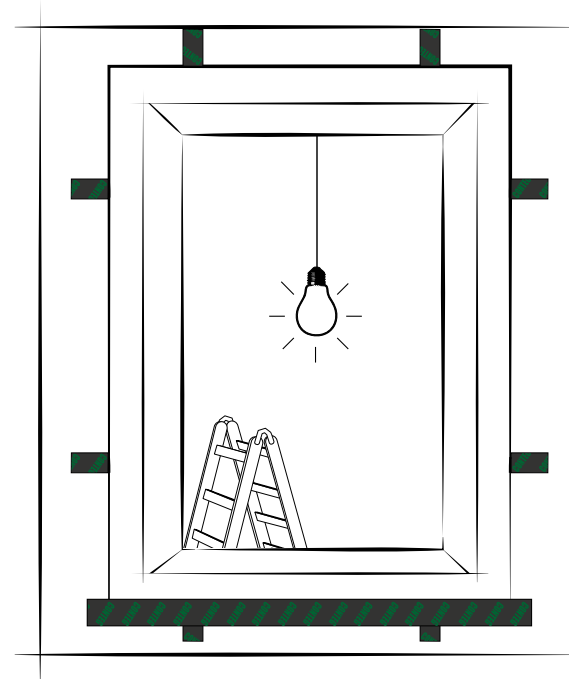

Note
 Apply the tape in a waterproof manner, starting at the bottom of the window and working up. Do not tape over any drainage openings in the window!

4. Stick to the wall

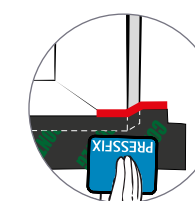
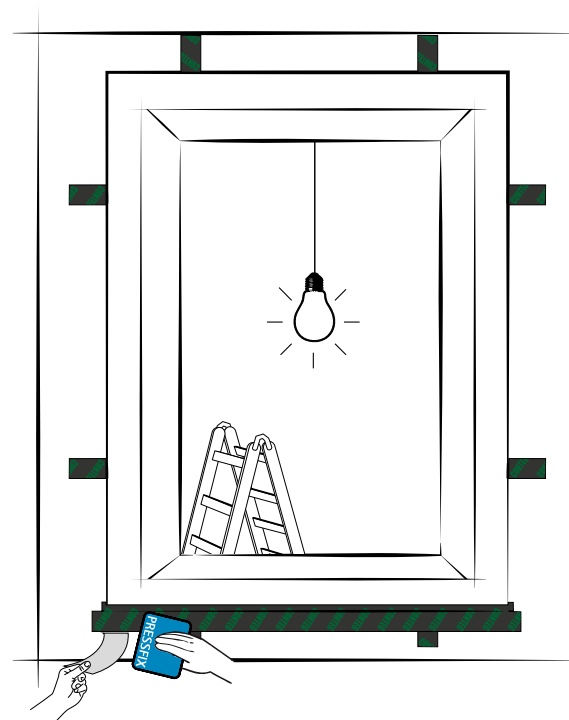

Tape application at the corners

Note
 Apply CONTEGA SOLIDO IQ around the corners of the window frame, ensuring there is no tension. Ensure that there are no folds in the outer area of the tape. After sticking, rub the tape firmly into place using the PRESSFIX application tool.

5. Creating the bond

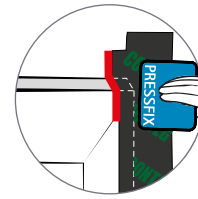
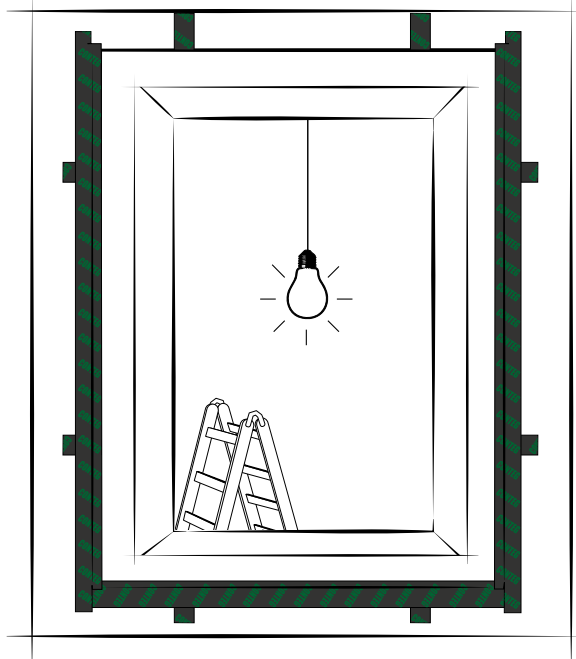

Install corner taping on the sides

**Note**

Apply CONTEGA SOLIDO IQ around the corners of the window frame, ensuring there is no tension. Ensure that there are no folds in the outer area of the tape. After sticking, rub the tape firmly into place using the PRESSFIX application tool.

6. Create the upper joint

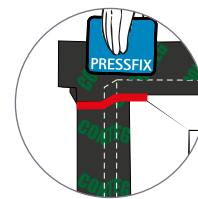
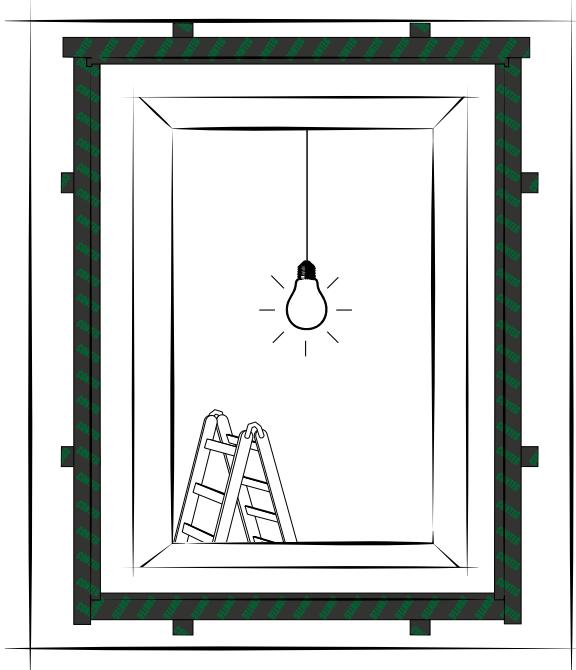

Install corner taping at the top

7. Installation in front of the wall: finished

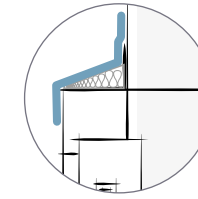
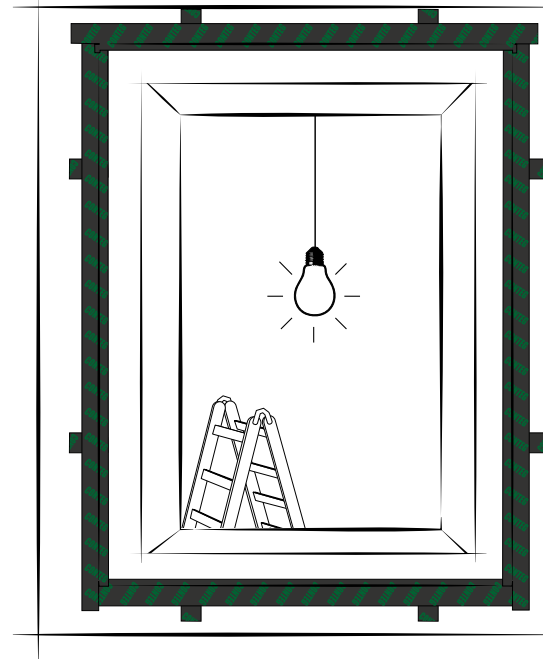

You're finished!

**Note**

Before applying the tape, a wedge-shaped (insulation) profile can be installed on the window frame to prevent the collection of standing water on the top surface.

4. Stick to the wall

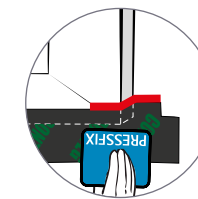
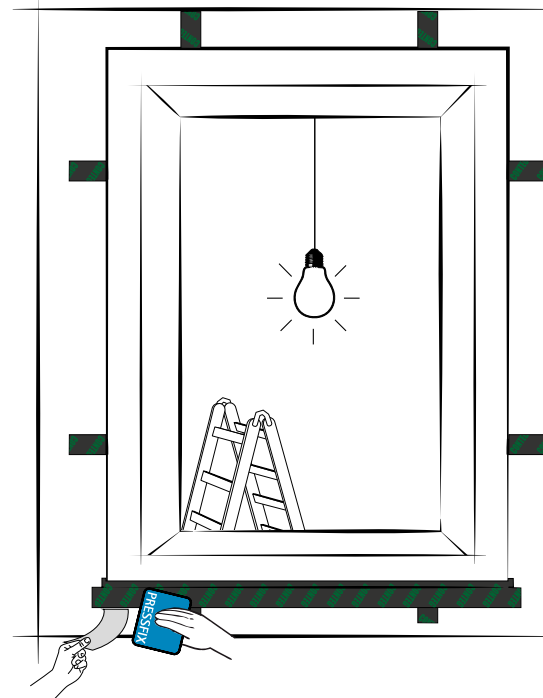

Tape application at the corners

**Note**

Apply CONTEGA SOLIDO IQ around the corners of the window frame, ensuring there is no tension. Ensure that there are no folds in the outer area of the tape. After sticking, rub the tape firmly into place using the PRESSFIX application tool.

Quality assurance, acceptance and documentation

1. Visual inspection on the inside and outside

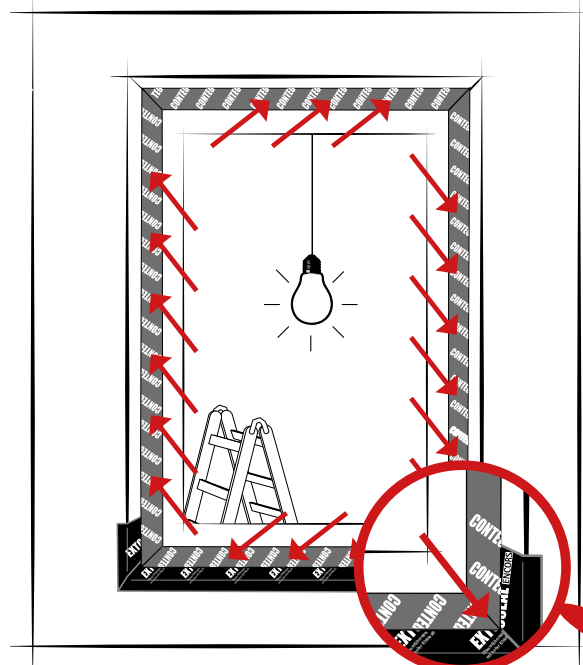

Note

Careful visual inspection of work carried out is essential. This check, along with documentation of quality, should be carried out before other trades begin their work. At this stage, improvements can still be carried out quickly and easily.



Practical tip

Take photos of the installed window. This does not take much time, but is very useful: you can document the quality of your work before subsequent trades start their work.

2. Differential pressure test with Blower Door



BlowerDoor

The BlowerDoor procedure is a testing method that creates a differential pressure in the building. This differential pressure allows defects in joints to be identified and rectified. This procedure can also be used to measure the air change rate (n_{50}) in the building.



Practical tip

Consult with other trades (e.g. roofers, carpenters, plasterers...) beforehand, as a Blower Door test may already be planned and a number of trades can then take advantage of this test at the same time. And the client will save money too!



Quick answers relating to building physics, construction, systems or products. Our engineers from the field of Timber and General Construction can help you quickly and simply in an expert manner and help you find solutions for cost-effective, reliable constructions that will create healthy living environments.

Phone: +49 (0) 62 02-27 82 45
E-mail: support@proclima.com
proclima.info/en/technical-support

Technical support

- ✓ Quick answers to your questions relating to building physics
- ✓ Engineers from pro clima's Application Technology department can help you with their specialist knowledge
- ✓ Evaluation of structures and designs
- ✓ Advice on applications and use of systems and products
- ✓ Evaluation and approval of structures and components



Detailed CAD drawings



All drawings are available for download at:
proclima.info/en/cad-drawings



The pro clima database of CAD detail features provides you with a range of suggested solutions for planning and implementing your construction projects. Drawings showing how to achieve airtightness and windtightness at detail features are available to be downloaded for free in the form of DWG files, DXF files or PDF files. The drawings are grouped by construction type (timber frame and solid timber construction) and by the type of details – for example: base joints, component transitions, pitched roofs, flat roofs, windows and penetrations. A number of variants are available for many of the construction situations.

Timber Frame Construction detail features

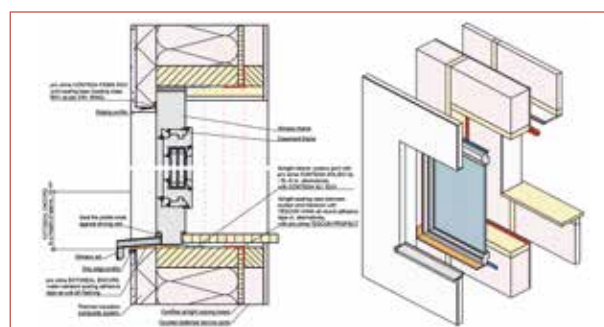

Solid Timber Construction detail features

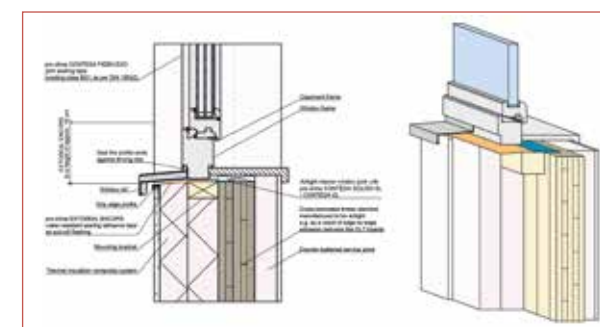

Suppliers and distributors around the world

pro clima is a pioneer in intelligent airtightness. We are active all around the world, supplying complete sealing systems for interior and exterior use – with intelligent membranes, solutions for connections, and a full range of associated services.

Head office:

pro clima – MOLL bauökologische Produkte GmbH

Rheintalstraße 35–43 · 68723 Schwetzingen · Germany

Phone: +49 (0) 62 02 – 27 82 0

info@proclima.com

proclima.com



Australia

pro clima Australia Pty Ltd
Level 3, 15 – 21 Doody St.
Alexandria, Sydney, NSW 2015
☎ +61 2 9160 8300
welcome@proclima.com.au
www.proclima.com.au

Austria

Vinzenz Harrer GmbH
Badl 31
A-8130 Frohnleiten
☎ +43 (0) 31 27 – 20 945
☎ +43 (0) 31 27 – 20 945 218
office@harrer.at
www.harrer.at

Belgium

ISOPROC
Boterstraat 23a
2811 Mechelen (Hombeek)
☎ +32 15 62 39 35
☎ +32 15 62 39 36
info@isoproc.be
www.isoproc.be
be-nl.proclima.com
be-fr.proclima.com

Canada

475 High Performance
Building Supply
1425 Marine Drive, Suite #207
West Vancouver, BC
V7T 1B9
Canada
☎ +1 800 – 995 63 29
info@475.supply
ca.475.supply

Chile

For a list of stockists
please contact:
worldwide-support@
proclima.com
www.proclima.com

Czech Republic

CIUR a.s.
Pražská 1012
250 01 Brandýs nad Labem
Czech Republic
☎ +420 326 901 411
☎ +420 326 901 456
info@ciur.cz
www.ciur.cz
www.pro-clima.cz

Denmark

BetaPack a/s
Agerskovvej 9
8362 Hørning
☎ +45 70 20 87 00
js@betapack.dk
www.betapack.dk

Estonia

Tervemaja OÜ
Tähe 135A
50107 Tartu
☎ +372 740 55 09
☎ +372 56 509 709
tervemaja@tervemaja.ee
www.tervemaja.ee

Finland

Tiivistalo / Redi-Yhtiöt Oy
Yrittäjätie 24
01800 KLAUKKALA
☎ +358 (0)207 439 670
info@tiivistalo.fi
www.tiivistalo.fi

France

pro clima France SARL
3 quai Jacques Sturm
67000 Strasbourg
☎ +33 1 86 37 00 70
info@proclima.info
www.proclima.info

Great Britain

Ecological Buildings Systems
Cardewlees, Carlisle
Cumbria, CA5 6LF, UK
☎ +44 1228 711 511
☎ +44 1228 712 280
info@ecological
buildingsystems.com
www.ecologicalbuilding
systems.com

Greece

Aerismos.gr
Lysiou 11, Ilioupoli, 16346
☎ +30 210 9714722
info@aerismos.gr
www.aerismos.gr

Iceland

Redder ehf byggingalausnir
Hyrjarhofda 2
110 Reykjavik / Iceland
☎ +35 45 58 08 88
redder@redder.is
www.redder.is

Ireland & Northern Ireland

Ecological Building Systems
Main Street, Athboy
County Meath
C15 Y678
Republic of Ireland
☎ +353 46 94 32 104
info@ecological
buildingsystems.com
www.ecologicalbuilding
systems.com

Italy

Naturalia-Bau srl
Via Carlo Abarth Str. 20
39012 Meran / Merano (BZ)
☎ +39 0473 499 050
☎ +39 0473 499 060
info@naturalia-bau.it
www.naturalia-bau.it

Japan

EcoTransfer Japan K.K.
Imas Office Bakurocho Bldg. 6F
1-5-6 Nihonbashi Bakurocho
Chuo-ku, Tokyo 103-0002
☎ +81 50 34 95 – 25 80
☎ +81 50 34 58 – 06 37
info@ecotransfer-japan.com
www.ecotransfer-japan.com

Kazakhstan

50 Pascal (T00 Greenbuild)
Zenkova Str. 22, 124
050000 Almaty
Kazakhstan
☎ +7 705 962 3463
info@50pascal.kz
www.50pascal.kz

Latvia

Artiva Ltd
Sila iela 9 Riga, LV-1057
Office: Katlakalna iela 1,
Riga, LV-1073
☎ +371 29 25 28 82
☎ +371 29 11 61 16
info@artiva.lv
www.artiva.lv
www.proclima.lv

Lithuania

Ekologiški statybos
produktai UAB
»ProClima« Atstovas Lietuvoje
Parašykite: info@proclima.lt
www.proclima.lt

Luxembourg

MOLL bauökologische
Produkte GmbH
Rheintalstraße 35–43
D-68723 Schwetzingen
Germany
☎ +49 6202 27 82 0
France
☎ +33 1 86 37 00 70

Mexico

For a list of stockists
please contact:
worldwide-support@
proclima.com
www.proclima.com

Netherlands

For a list of stockists
please contact:
worldwide-support@
proclima.com
nl.proclima.com

New Zealand

Pro Clima NZ Ltd
Level 1, 47 The Esplanade
Petone, Lower Hutt 5012
☎ +64 4 589 8460
welcome@proclima.co.nz
www.proclima.co.nz

Norway

For a list of stockists
please contact:
worldwide-support@
proclima.com
www.proclima.com

Poland

For a list of stockists
please contact:
worldwide-support@
proclima.com
www.proclima.com

Portugal

EUROBUILD
Zona Industrial de Febres,
Lote 14
3060-318 Febres
☎ +351 231 027 943
info@eurobuild.pt
www.eurobuild.pt

Romania

nZEBshop - Magazin pentru
case inteligente
Strada Icoanei 15,
Sector 2, București
România
☎ +40 734 999 444
info@nzebshop.ro
www.nzebshop.ro

Russia

For a list of stockists
please contact:
worldwide-support@
proclima.com
www.proclima.com

Slovakia

VUNO HREUS, s.r.o.
Kvačalová 1207/47
010 04 Žilina
Slovak Republic
☎ +421 41 56 26 799
vuno@vuno.sk
www.vuno.sk
www.proclima.sk

Slovenia

Vinzenz Harrer GmbH
Badl 31
A-8130 Frohnleiten
☎ +43 (0) 31 27 – 20 945
☎ +43 (0) 31 27 – 20 945 218
office@harrer.at
www.harrer.at

South Korea

Proclima Korea
Suyang-ri 474-3
Gonjam-eup / Gwangju-si
529-851 GYEONGGI-DO
☎ +82 (0) 31 – 797 5473
☎ +82 (0) 31 – 797 5472
info@proclima.co.kr
www.proclima.co.kr

Spain

Sistemas Pasivos Materiales Activos S.L.
c/Eduardo Dato-42-1º
E-01005 Vitoria – Gasteiz
☎ +34 945 15 71 58
proclima@sistemaspasivos.es
www.sistemaspasivos.es

Sweden

ISOLERINGSLANDSLAGET AB
Gamla tallet, Stora Wäsby
19437 Upplands Väsby
☎ +46 20 44 66 40
info@isoleringslandslaget.se
www.isoleringslandslaget.se

Switzerland

pro clima schweiz GmbH
Teichgässlein 9
4058 Basel
info@proclima.ch
www.proclima.ch

Turkey

For a list of stockists
please contact:
worldwide-support@
proclima.com
www.proclima.com

USA

475 High Performance
Building Supply
334 Douglass Street
Brooklyn, NY 11217
☎ +1 800 – 995 63 29
info@475.supply
www.475.supply

MOLL bauökologische Produkte GmbH

Rheintalstraße 35 - 43 · D-68723 Schwetzingen · Germany

Phone: +49 (0) 62 02 - 27 82.0 · E-mail: info@proclima.com · proclima.com



Your pro clima partner

2024-03 1AR01399

The applications and conditions described here are based on current state-of-the-art research and practical experience. We reserve the right to change the recommended structures and installation methods and to further develop and thus alter the quality of individual products. We would be glad to inform you about the current state of engineering knowledge at the time that your installation is carried out.